

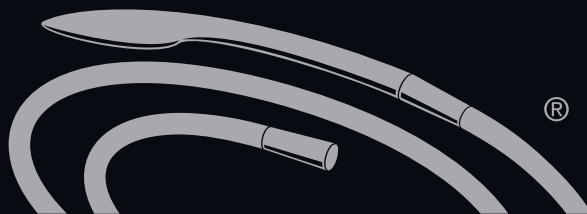

duchaflex[®]
S I N C E 1 9 8 2

TARIFA OPERATIVA





Duchaflex, empresa constituida en el año 1982 y especializada en la producción de accesorios para fontanería en la que, la fuerza de voluntad, la experiencia, la determinación en los objetivos y el espíritu empresarial de los fundadores han sido los fundamentos que han llevado la sociedad a interpretar un camino evolutivo siempre en sintonía con las exigencias del mercado, sea español o extranjero.

1	Válvulas y sifones en latón	6	5	Peluquería	90
	Válvulas planas para lavabo	8			
	Expositores valvulería	15	6	Grifería para cocina industrial	94
	Accesorios válvulas	18		Flexo y rociador para cocina industrial	97
	Sifones en latón	20		Equipos industriales	98
	Accesorios para sifones	28		Grifería industrial	108
	Válvulas para plato de ducha	30		Recambios	114
	Desagües para ducha y bañera	34		Grifería de columna	118
	Canaletas para ducha	36		Grifería con pedal	120
2	Válvulas y manguitos en plástico	46		Caños giratorios	123
	Válvulas cesta para fregadero	48		Limpieza para hornos	124
	Válvulas para lavabo y fregadero	50	7	Grifos para fregadero y lavadora	126
	Sifones en goma y manguitos en plástico	52		Grifos con volante latón grafilado	128
3	Mangos de ducha y flexos	54		Grifos con volante walter	131
	Mangos de ducha High Line	56		Grifos con volante metacrilato	134
	Kits de ducha	58		Recambios	136
	Mangos de ducha Premium Line	62	8	Excéntricas y florones	138
	Expositores mangos de ducha	64			
	Mango de ducha Básic Line	68	9	Aireadores y reducciones	144
	Soportes y tomas para ducha	70		Aireadores para lavabo y fregadero	146
	Rociadores y brazos de ducha	72		Aireadores para bañera y bidé	150
	Flexos de ducha	74		Aireadores para cocina	151
	Mangos y flexos para fregadero	78		Aireadores para grifería minimalista	152
	Conjuntos WC	80		Recambios para aireadores	153
	Expositores kits WC	82		Reducciones	154
4	Tubos lavadora y Manguitos WC	84			
	Tubos para lavadora	86			
	Manguitos para WC	88			

10	Línea de descargas TA y TB	156
	Descargas T-A plomo	158
	Descargas T-A muelle	160
	Recambios para descargas	160
	Tornillería	162
	Tiradores	164
	Descargas T-B	166
	Juntas	166
11	Asideros bañera y monturas	168
	Asideros	170
	Rosetas tapa agujeros	170
	Rejillas	171
	Monturas	171
12	Juntas	172
	Kits juntas indispensables	174
	Juntas goma EPDM	175
	Juntas Klingerit	176
	Juntas PTFE	177
	Juntas con filtro y cónicas	178
	Juntas planas y semicónicas blancas	179
	Maletines de juntas	180
	Posters publicitarios	184
	Índice de Referencias	186







1



Válvula plana latón para lavabo

- Rosca 1" 1/4 G. · Cazoleta en acero inoxidable AISI 304 cromada
- Tapón en latón cromado · Cadena de 30 cm. en latón cromado

Ref.	Embalaje	Uds.	Precio u.
7133	Bolsa ind.	10 u.	10,750 €
71331	Skin	10 u.	11,350 €

NUEVO



Válvula plana latón para lavabo

- Rosca 1" 1/4 G. · Cazoleta en acero inoxidable AISI 304 · Tapón en goma remachado

Ref.	Embalaje	Uds.	Precio u.
7444	Bolsa ind.	10 u.	5,950 €
74441	Skin	10 u.	6,550 €

NUEVO



Válvula latón sin tapón para lavabo

- Rosca 1" 1/4 G. · Cazoleta en acero inoxidable AISI 304 cromada

Ref.	Embalaje	Uds.	Precio u.
7555	Bolsa ind.	10 u.	5,550 €
75551	Skin	10 u.	6,150 €



Válvula latón para lavabo

- Rosca 1" 1/4 G. · Fabricada en latón cromado · Tapón en latón cromado · Cadena de 30 cm. en latón cromado

Ref.	Embalaje	Uds.	Precio u.
3292	Bolsa ind.	10 u.	14,250 €

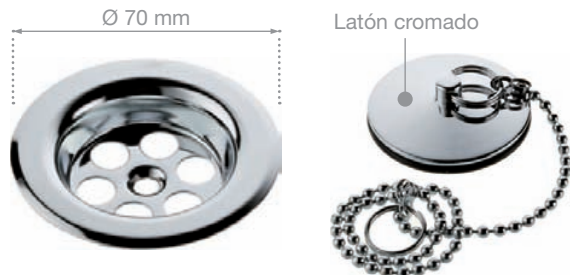

Conjunto lavabo/bidé

· Cazoleta acero inoxidable AISI 304 cromado · Tapón en latón cromado · Cadena de 30 cm. en latón cromado

Ref.	Embalaje	Uds.	Precio u.
8760	Caja	1 u.	7,500 €



Tapón y cadena

· Tapón en latón cromado · Cadena de 30 cm. en latón cromado

Ref.	Embalaje	Uds.	Precio u.
8765	Caja	1 u.	5,845 €



Presentada en caja transparente PET 100% reciclable



Válvula para lavabo

· Rosca 1" 1/4 G. · Tapón roscado · Especial para lavabos sin rebosadero · Fabricada en latón cromado

Ref.	Embalaje	Uds.	Precio u.
4800	Caja	1 u.	23,950 €

1



Válvulas Universales Click-Clack



- Válidas para todos los lavabos, con o sin rebosadero
- Sistema Click-Clack anticalcáreo
- Fabricadas totalmente en latón barra
- 20.000 ciclos click-clack garantizados
- Montaje rápido y sencillo



Todas las válvulas Click-Clack están presentadas en caja transparente PET 100% reciclable

Características:



Possibilidad de convertir a rosca 1" 1/2 G. mediante la ref. 4599 (pág. 19)



Válvula Click-Clack tapón porcelana blanca

· Rosca 1" 1/4 G.

Ref.	Producto	Embalaje	Uds.	Precio u.
4000	Válvula completa	Caja	1 u.	39,750 €
4050	Tapón recambio	Caja	1 u.	29,500 €



Válvula Click-Clack tapón redondo

· Rosca 1" 1/4 G.

Ref.	Producto	Embalaje	Uds.	Precio u.
4500	Válvula completa	Caja	2 u.	27,750 €
4550	Tapón recambio	Caja	1 u.	15,250 €



Válvula Click-Clack tapón slim

· Rosca 1" 1/4 G.

Ref.	Producto	Embalaje	Uds.	Precio u.
4300	Válvula completa	Caja	2 u.	23,509 €
4350	Tapón recambio	Caja	1 u.	12,325 €



Válvula Click-Clack tapón cuadrado

· Rosca 1" 1/4 G.

Ref.	Producto	Embalaje	Uds.	Precio u.
4600	Válvula completa	Caja	1 u.	46,602 €
4650	Tapón recambio	Caja	1 u.	24,344 €



Válvula Click-Clack tapón oval

· Rosca 1" 1/4 G.

Ref.	Producto	Embalaje	Uds.	Precio u.
4400	Válvula completa	Caja	1 u.	46,602 €
4450	Tapón recambio	Caja	1 u.	27,847 €

1



Válvula Click-Clack All Inox Steel AISI 316

· Rosca 1" 1/4 G. · Fabricada totalmente en acero inox AISI 316

Ref.	Producto	Embalaje	Uds.	Precio u.
8410	Válvula completa	Caja	1 u.	189,571 €
8412	Tapón recambio	Caja	1 u.	52,607 €



Válvula Click-Clack Oro satinado

· Rosca 1" 1/4 G.

Ref.	Producto	Embalaje	Uds.	Precio u.
4514	Válvula completa	Caja	1 u.	55,750 €
4504	Tapón recambio	Caja	1 u.	28,500 €



Válvula Click-Clack Oro Viejo

· Rosca 1" 1/4 G.

Ref.	Producto	Embalaje	Uds.	Precio u.
4515	Válvula completa	Caja	1 u.	43,750 €
4510	Tapón recambio	Caja	1 u.	21,950 €



Válvula Click-Clack Bronce

· Rosca 1" 1/4 G.

Ref.	Producto	Embalaje	Uds.	Precio u.
4090	Válvula completa	Caja	1 u.	43,750 €
4506	Tapón recambio	Caja	1 u.	21,950 €



Válvula Click-Clack latón Inox Satinado

· Rosca 1" 1/4 G.

Ref.	Producto	Embalaje	Uds.	Precio u.
4512	Válvula completa	Caja	1 u.	47,500 €
4501	Tapón recambio	Caja	1 u.	22,650 €



Válvula Click-Clack Cromado Satinado

· Rosca 1" 1/4 G.

Ref.	Producto	Embalaje	Uds.	Precio u.
4513	Válvula completa	Caja	1 u.	43,750 €
4507	Tapón recambio	Caja	1 u.	21,950 €



Válvula Click-Clack Mármol Carrara

· Rosca 1" 1/4 G.

Ref.	Producto	Embalaje	Uds.	Precio u.
4120	Válvula completa	Caja	1 u.	43,500 €
4125	Tapón recambio	Caja	1 u.	27,500 €



Válvula Click-Clack Mármol Negro

· Rosca 1" 1/4 G.

Ref.	Producto	Embalaje	Uds.	Precio u.
4055	Válvula completa	Caja	1 u.	43,500 €
4508	Tapón recambio	Caja	1 u.	27,500 €

1



Válvula Click-Clack Madera Clara

· Rosca 1" 1/4 G.

Ref.	Producto	Embalaje	Uds.	Precio u.
4130	Válvula completa	Caja	1 u.	43,500 €
4510	Tapón recambio	Caja	1 u.	27,500 €



Válvula Click-Clack Madera Oscura

· Rosca 1" 1/4 G.

Ref.	Producto	Embalaje	Uds.	Precio u.
4035	Válvula completa	Caja	1 u.	43,500 €
4511	Tapón recambio	Caja	1 u.	27,500 €



Válvula Click-Clack Tierra

· Rosca 1" 1/4 G.

Ref.	Producto	Embalaje	Uds.	Precio u.
4070	Válvula completa	Caja	1 u.	43,500 €
4509	Tapón recambio	Caja	1 u.	27,500 €





Válvula Click-Clack Carbono

· Rosca 1" 1/4 G.

Ref.	Producto	Embalaje	Uds.	Precio u.
4140	Válvula completa	Caja	1 u.	43,500 €
4145	Tapón recambio	Caja	1 u.	27,500 €



 **Ref. 4500 x 8**
PVP normal: 27,750 €
PVP en expositor: 26,920 €

 **Ref. 4000 x 2**
PVP normal: 39,750 €
PVP en expositor: 38,560 €

 **Ref. 4600 x 1**
PVP normal: 46,602 €
PVP en expositor: 45,200 €

 **Ref. 4300 x 1**
PVP normal: 23,509 €
PVP en expositor: 22,804 €

Expositor valvulería Premium
· 12 válvulas

Ref.	Embalaje	Uds.	Precio u.
8414	Caja	1 u.	360,462 €





 **Ref. 4055 x1**
PVP normal: 43,500 €
PVP en expositor: 42,200 €

 **Ref. 4035**
PVP normal: 43,500 €
PVP en expositor: 42,200 €

 **Ref. 4130 x1**
PVP normal: 43,500 €
PVP en expositor: 42,200 €

 **Ref. 4513 x1**
PVP normal: 43,750 €
PVP en expositor: 42,440 €

 **Ref. 4000 x1**
PVP normal: 39,750 €
PVP en expositor: 38,560 €

 **Ref. 4070 x1**
PVP normal: 43,500 €
PVP en expositor: 42,200 €

 **Ref. 4120 x1**
PVP normal: 43,500 €
PVP en expositor: 42,200 €

 **Ref. 4090 x1**
PVP normal: 43,750 €
PVP en expositor: 42,440 €

 **Ref. 4515 x1**
PVP normal: 43,750 €
PVP en expositor: 42,440 €

 **Ref. 4514 x1**
PVP normal: 55,750 €
PVP en expositor: 54,078 €

 **Ref. 4512 x1**
PVP normal: 43,700 €
PVP en expositor: 46,075 €

 **Ref. 4140 x1**
PVP normal: 43,500 €
PVP en expositor: 42,200 €

Expositor valvulería Colors High
· 12 válvulas

Ref.	Embalaje	Uds.	Precio u.
8416	Caja	1 u.	519,900 €

1



Ref. 4500 x 12

PVP normal: 27,750 €

PVP en expositor: 26,625 €



Ref. 4000 x 12

PVP normal: 39,750 €

PVP en expositor: 39,580 €

Expositor valvulería 4500

· 12 válvulas ref. 4500

Ref.	Embalaje	Uds.	Precio u.
8413	Caja	1 u.	319,500 €

Expositor valvulería 4000

· 12 válvulas ref. 4000

Ref.	Embalaje	Uds.	Precio u.
8425	Caja	1 u.	475,000 €



Ref. 4500 x 6

PVP normal: 27,750-€
PVP en expositor: 26,625 €



Ref. 4000 x 6

PVP normal: 39,750-€
PVP en expositor: 39,580 €

Expositor valvulería 4000/4500

· 6 válvulas ref. 4500 y 6 válvulas ref. 4000

Ref.	Embalaje	Uds.	Precio u.
8430	Caja	1 u.	392,230 €



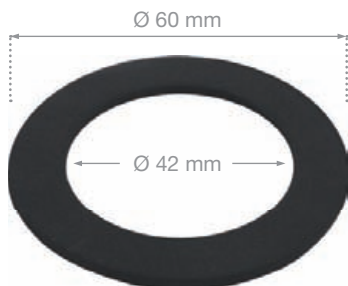

Junta recambio superior

· Fabricada en espuma

Ref.	Embalaje	Uds.	Precio u.
45503	Caja	5 u.	0,775 €

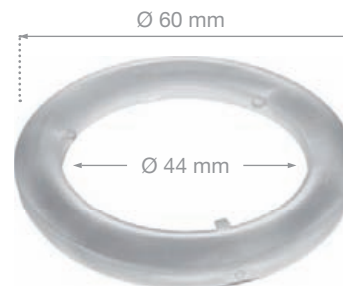

Junta recambio inferior

· Fabricada en silicona virgen

Ref.	Embalaje	Uds.	Precio u.
45502	Caja	5 u.	0,852 €



Junta recambio de cierre

· Fabricada en goma NBR 90°

Ref.	Embalaje	Uds.	Precio u.
45501	Caja	5 u.	0,557 €

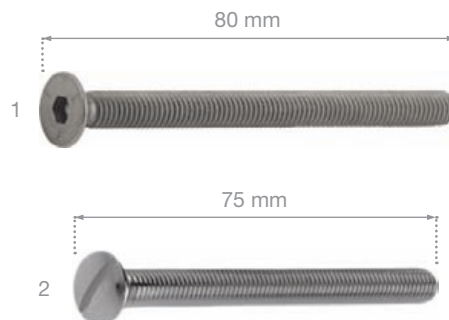

Tornillos recambio

· Fabricados en acero inoxidable 18/8

Ref.	Producto	Embalaje	Uds.	Precio u.
45504	1 - Allen M6 x 80 mm.	Caja	25 u.	1,767 €
33292	2 - Plano M6 x 75 mm.	Caja	25 u.	0,846 €

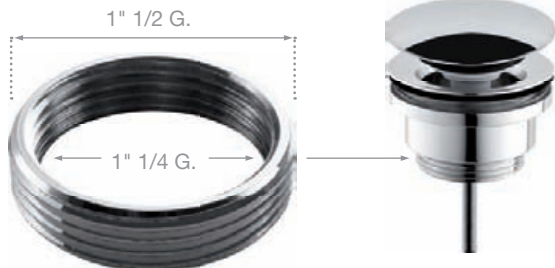

Aro reducción

· Especial para válvulas Click-Clack · Reducción de 1" 1/4 G. a 1" 1/2 G. · Fabricado en latón barra cromado

Ref.	Embalaje	Uds.	Precio u.
4599	Caja	2 u.	6,500 €



Casquillo cubre válvula con rebosadero

· Fabricado en latón cromado

Ref.	Embalaje	Uds.	Precio u.
8020	Caja	1 u.	23,865 €



Casquillo cubre válvula

· Fabricado en latón acabado cromado

Ref.	Embalaje	Uds.	Precio u.
7954	Bolsa ind.	10 u.	5,955 €



Casquillo cubre válvula

· Fabricado en latón acabado cromado

Ref.	Embalaje	Uds.	Precio u.
7964	Bolsa ind.	10 u.	5,955 €

BASIC LINE

1



Sifón redondo para lavabo

· Rosca 1" 1/4 G. · Fabricado en latón DIN 17 660 cromado

Ref.	Embalaje	Uds.	Precio u.
8150	Caja	4 u.	36,650 €



Sifón redondo para lavabo con junta unión metal/plástico

· Rosca 1" 1/4 G. · Fabricado en latón DIN 17 660 cromado
· Junta Ø 40 x Ø 32 mm · Florón Ø 75 x 31 mm

Ref.	Embalaje	Uds.	Precio u.
8155	Caja	4 u.	39,500 €



Sifón botella para lavabo

· Rosca 1" 1/4 G. · Fabricado en latón DIN 17 660 cromado

Ref.	Embalaje	Uds.	Precio u.
3313	Caja	10 u.	14,500€



Sifón botella para lavabo con junta unión metal/plástico

· Rosca 1" 1/4 G. · Fabricado en latón DIN 17 660 cromado
· Junta Ø 40 x Ø 32 mm · Florón Ø 75 x 31 mm

Ref.	Embalaje	Uds.	Precio u.
3350	Caja	10 u.	16,950 €



Ideal para cualquier instalación

Sifón giratorio para lavabo

· Rosca 1" 1/4 G. · Fabricado en latón DIN 17 660 cromado

Ref.	Embalaje	Uds.	Precio u.
8650	Caja	4 u.	14,750 €



Sifón giratorio para lavabo con junta unión metal/plástico

· Rosca 1" 1/4 G. · Fabricado en latón DIN 17 660 cromado
· Junta Ø 40 x Ø 32 mm · Florón Ø 75 x 31 mm

Ref.	Embalaje	Uds.	Precio u.
8660	Caja	4 u.	17,500 €



Sifón botella para bidé

· Rosca 1" 1/4 G. · Fabricado en latón DIN 17 660 cromado

Ref.	Embalaje	Uds.	Precio u.
3314	Caja	10 u.	14,750 €



Sifón botella para bidé con junta unión metal/plástico

· Rosca 1" 1/4 G. · Fabricado en latón DIN 17 660 cromado
· Junta Ø 40 x Ø 32 mm · Florón Ø 75 x 31 mm

Ref.	Embalaje	Uds.	Precio u.
3360	Caja	10 u.	17,500 €

HIGH
LINE

1

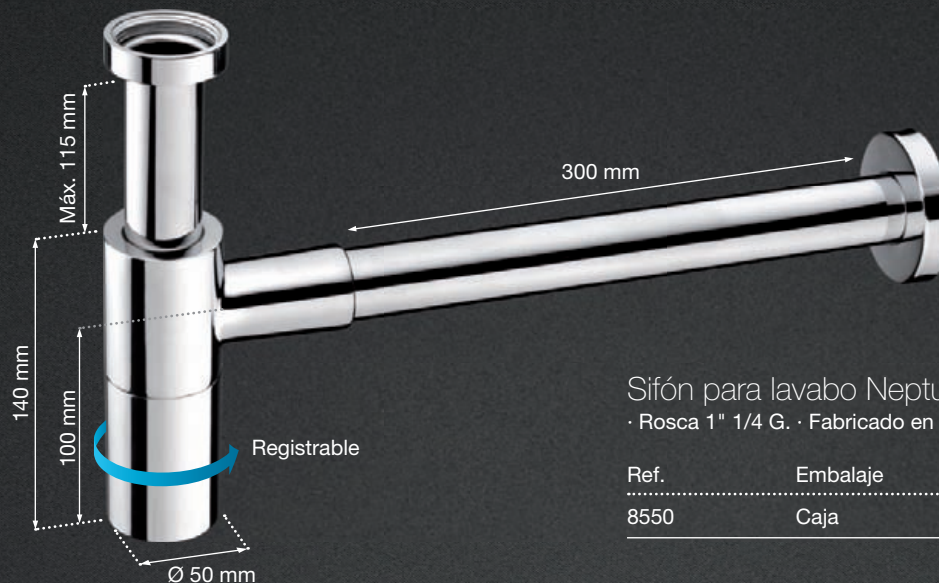

Sifón para lavabo Neptuno

· Rosca 1" 1/4 G. · Fabricado en latón DIN 17 660 cromado

Ref.	Embalaje	Uds.	Precio u.
8550	Caja	1 u.	62,500 €



ACERO INOXIDABLE

Sifón para lavabo Neptuno All Innox Steel AISI 316

· Rosca 1" 1/4 G. · Fabricado en acero inoxidable AISI 316

Ref.	Embalaje	Uds.	Precio u.
8400	Caja	1 u.	310,000 €

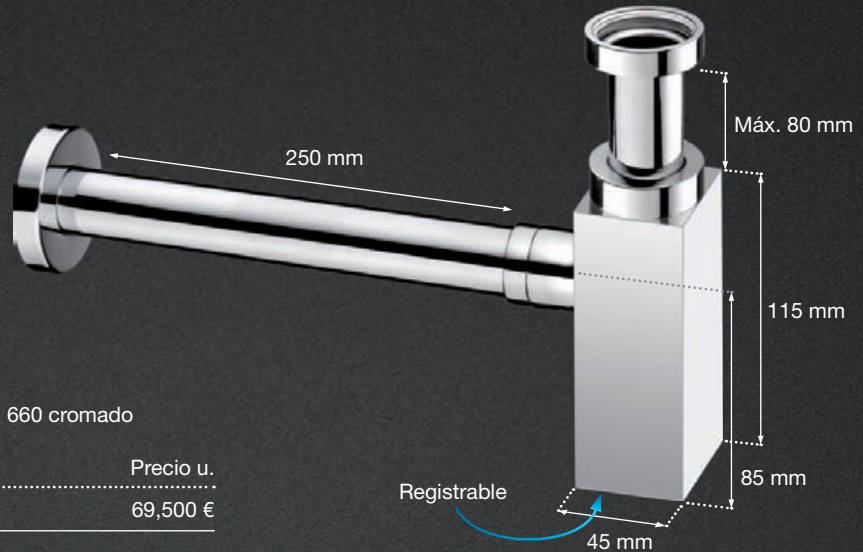

Sifón para lavabo Júpiter

· Rosca 1" 1/4 G. · Fabricado en latón DIN 17 660 cromado

Ref.	Embalaje	Uds.	Precio u.
8000	Caja	1 u.	69,500 €

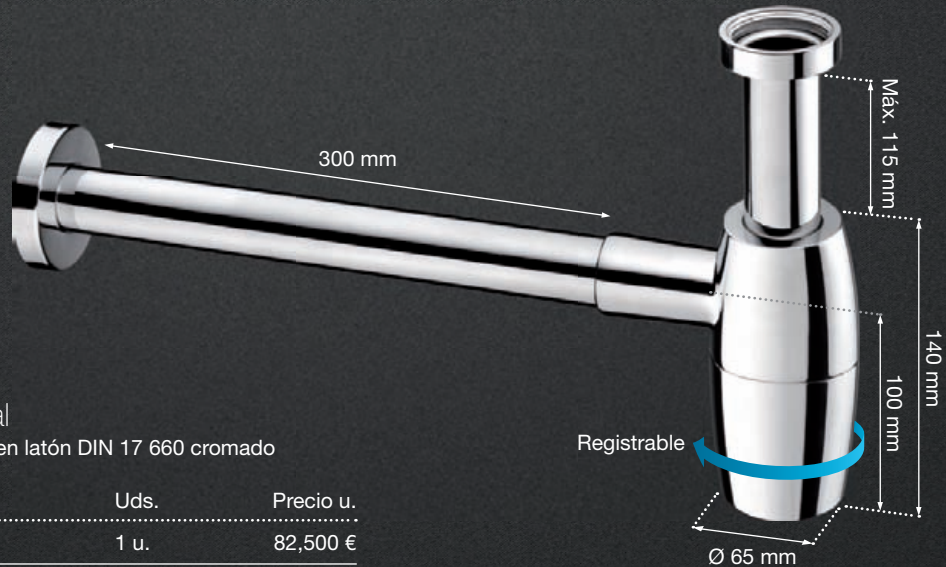

Sifón para lavabo Oval

· Rosca 1" 1/4 G. · Fabricado en latón DIN 17 660 cromado

Ref.	Embalaje	Uds.	Precio u.
8025	Caja	1 u.	82,500 €

colors

1

Mármol Carrara

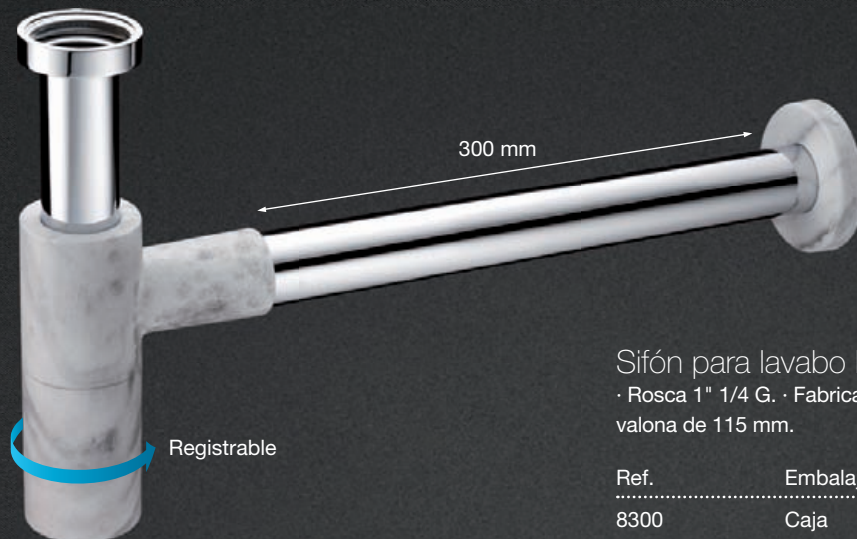

Sifón para lavabo Neptuno Mármol Carrara

· Rosca 1" 1/4 G. · Fabricado en latón barra DIN 17 660 · Tubo con valona de 115 mm.

Ref.	Embalaje	Uds.	Precio u.
8300	Caja	1 u.	150,000 €

Latón Oro Satinado



Sifón para lavabo Neptuno Oro Satinado

· Rosca 1" 1/4 G. · Fabricado en latón barra DIN 17 660 · Tubo con valona de 115 mm.

Ref.	Embalaje	Uds.	Precio u.
8552	Caja	1 u.	165,500 €

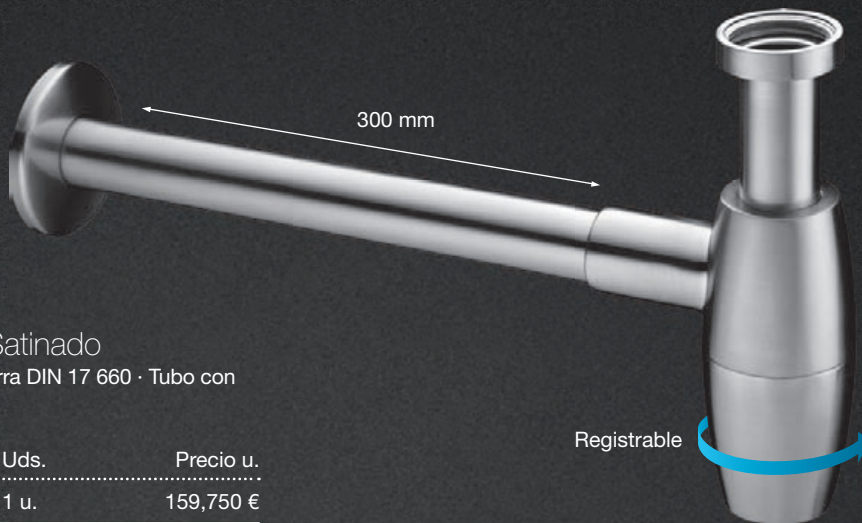

Latón Oval Inox Satinado

Sifón para lavabo Oval Inox Satinado

· Rosca 1" 1/4 G. · Fabricado en latón barra DIN 17 660 · Tubo con valona de 115 mm.

Ref.	Embalaje	Uds.	Precio u.
8026	Caja	1 u.	159,750 €

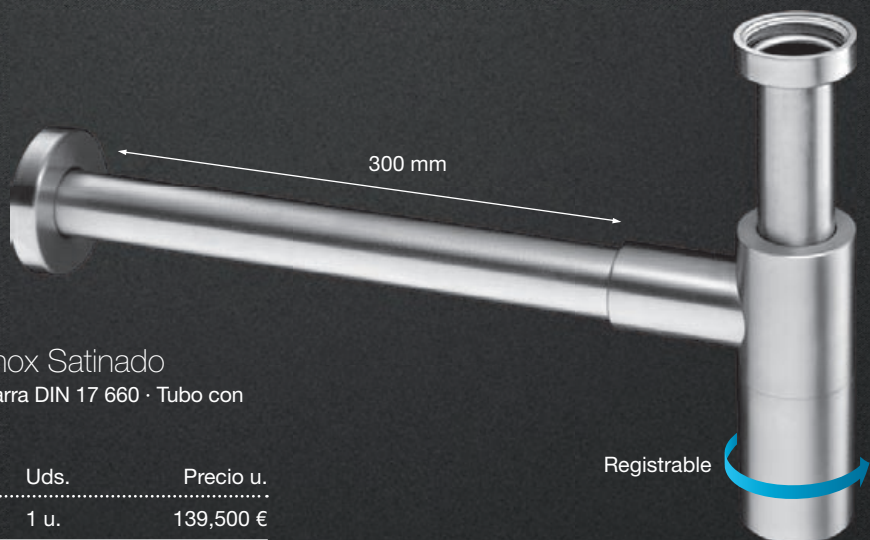

Latón Inox Satinado

Sifón para lavabo Neptuno Inox Satinado

· Rosca 1" 1/4 G. · Fabricado en latón barra DIN 17 660 · Tubo con valona de 115 mm.

Ref.	Embalaje	Uds.	Precio u.
8551	Caja	1 u.	139,500 €

colors



Sifón botella para lavabo oro satinado

· Rosca 1" 1/4 G. · Fabricado en latón DIN 17 660

Ref.	Embalaje	Uds.	Precio u.
3310	Caja	1 u.	108,570 €



Sifón botella para lavabo oro viejo

· Rosca 1" 1/4 G. · Fabricado en latón DIN 17 660

Ref.	Embalaje	Uds.	Precio u.
3312	Caja	1 u.	67,500 €



Sifón botella para lavabo bronce

· Rosca 1" 1/4 G. · Fabricado en latón DIN 17 660

Ref.	Embalaje	Uds.	Precio u.
3311	Caja	1 u.	67,500 €

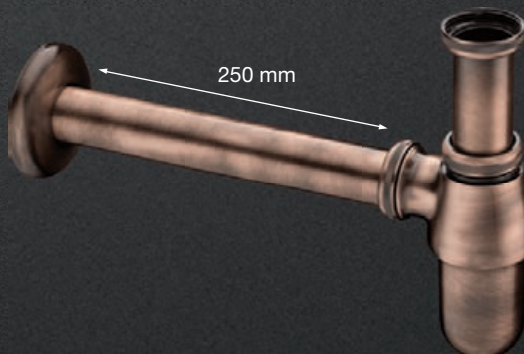



Expositores sifones con válvula

- A · Sifón y válvula Oval (refs. 8025 y 4400)
- B · Sifón y válvula mármol Carrara (refs.8300 y4120)
- C · Sifón Júpiter y válvula con tapón cuadrado (refs.8000 y 4600)
- D · Sifón y válvula All Inox Steel AISI 316 (refs. 8400 y 8410)
- E · Sifón Neptuno y válvula con tapón redondo (refs. 8550 y 4500)

Ref.	Expositor	Embalaje	Precio
8027	A	1 u. - Caja	195,750 €
8320	B	1 u. - Caja	240,000 €
8015	C	1 u. - Caja	195,750 €
8415	D	1 u. - Caja	550,000 €
8559	E	1 u. - Caja	155,000 €

1



Junta unión metal/plástico

· Ø 40 x Ø 32 mm · Para tubo de Ø 32 mm

Ref.	Embalaje	Uds.	Precio u.
8375	Caja	25 u.	1,902 €



Junta unión metal/plástico con florón

· Ø 40 x Ø 32 mm · Florón Ø 75 x 31 H mm · Para tubo de Ø 32 mm

Ref.	Embalaje	Uds.	Precio u.
8365	Bolsa ind.	12 u.	3,750 €
83651	Skin	10 u.	4,350 €



Tuercas recambio para sifón

· Rosca 1" 1/4 G. · Fabricada en latón cromado

Ref.	Producto	Embalaje	Uds.	Precio u.
7776	1 - Grafilada	Bolsa ind.	5 u.	2,150 €
7790	2 - Lisa	Bolsa ind.	5 u.	6,250 €



Codos y manguitos para sifón

· Fabricados en latón cromado

Ref.	Producto	Embalaje	Uds.	Precio u.
8450	1 - Codo M/M 1" 1/4 G.	Bolsa ind.	6 u.	7,965 €
8350	2 - Codo M/H 1" 1/4 G.	Bolsa ind.	6 u.	7,250 €
8475	3 - Manguito H/H 1" 1/4 G.	Bolsa ind.	6 u.	8,623 €

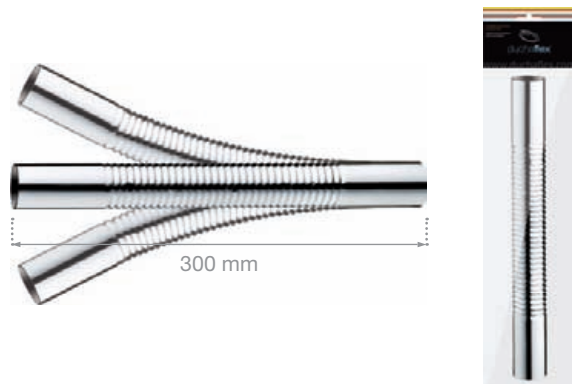

Tubo flexible para sifón

· 300 mm x Ø 32 mm · Fabricado en latón cromado

Ref.	Embalaje	Uds.	Precio u.
7812	Bolsa	10 u.	7,767 €
78121	Skin	10 u.	8,362 €



Manguito telescópico para sifón

· 130 mm x Ø 32 mm · Fabricado en latón cromado

Ref.	Embalaje	Uds.	Precio u.
6100	Bolsa ind.	8 u.	3,495 €

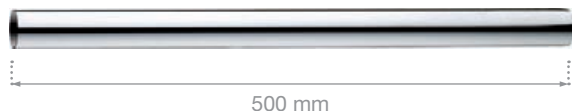

Tubo para sifón

· 500 mm x Ø 32 mm · Fabricado en latón cromado

Ref.	Embalaje	Uds.	Precio u.
3680	Bolsa	5 u.	6,755 €

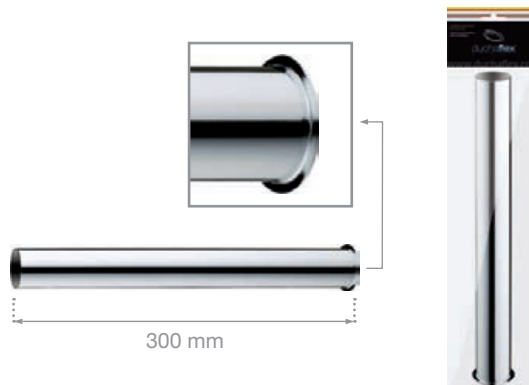

Tubo con valona para sifón

· 300 mm x Ø 32 mm · Fabricado en latón cromado

Ref.	Embalaje	Uds.	Precio u.
7596	Bolsa	10 u.	4,926 €
75961	Skin	10 u.	5,526 €

Válvulas para plato de ducha

- 1 - Tapa en acero inoxidable
- 2 - Tubo interior
- 3 - Bote sifónico
- 4 - Rosca superior
- 5 - Junta EPDM 70°
- 6 - Cuerpo en ABS
- 7 - Junta cónica Ø 40
- 8 - Rosca 1 1/2" G.
- 9 - Racor encolable



Llave de instalación incluida

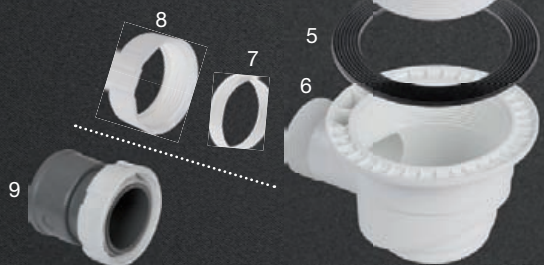

Presentadas en caja transparente PET 100% reciclable



Válvula para plato de ducha con orificio de 90 mm
 · Salida a desagüe de Ø 40 mm · Fabricada en ABS · Capacidad de evacuación 42 lit/min

Ref.	Embalaje	Uds.	Precio u.
4100	Caja transparente	8 u.	19,850 €



Válvula para plato de ducha con orificio de 90 mm
 · Salida a desagüe de Ø 40 mm · Fabricada en ABS · Capacidad de evacuación 42 lit/min

Ref.	Embalaje	Uds.	Precio u.
4110	Caja	6 u.	19,250 €



Válvula para plato de ducha con orificio de 90 mm
 · Salida a desagüe de Ø 40 mm · Fabricada en ABS · Capacidad de evacuación 42 lit/min

Ref.	Producto	Embalaje	Uds.	Precio u.
4150	Con racor	Caja	6 u.	19,250 €
4155	Sin racor	Caja	6 u.	18,250 €



Válvula para plato de ducha con orificio de 60 mm
 · Salida a desagüe de Ø 40 mm · Fabricada en ABS · Capacidad de evacuación 29 lit/min

Ref.	Embalaje	Uds.	Precio u.
4200	Caja transparente	8 u.	16,702 €



Recambios

Ref.	Producto	Embalaje	Uds.	Precio u.
410001	Tapa inox 4100	Bolsa	1 u.	6,950 €
420002	Tapa inox 4200	Bolsa	1 u.	4,255 €
41101	Tapa blanca	Bolsa	1 u.	4,255 €
410002	Junta 4100/6000	Caja	10 u.	1,750 €
420002	Junta 4200	Caja	10 u.	1,650 €

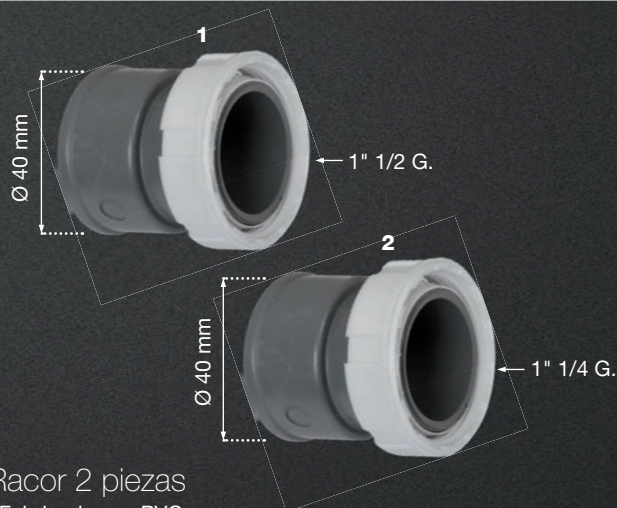

Racor 2 piezas
 · Fabricados en PVC

Ref.	Embalaje	Embalaje	Uds.	Precio u.
3731	1 - 1" 1/2 G. x Ø 40 mm	Bolsa	12 u.	1,495 €
3621	2 - 1" 1/4 G. x Ø 40 mm	Bolsa	12 u.	1,495 €

1

Válvula extraplana para plato de ducha



La tapa en acero inoxidable garantiza una sujeción segura gracias a sus 8 puntos de anclaje. Su caudal de evacuación, 56 lit/min, es muy superior al de la normativa, haciéndola idónea para platos de ducha muy planos o con poca capacidad de agua.

Suministrados 2 medidas de tornillos: 40 mm. y 60 mm. Adaptable a platos de ducha con gruesos de hasta a 50 mm.



Tornillos de 40 mm para gruesos inferiores a 18 mm.

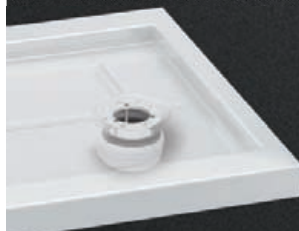

Tornillos de 60 mm para gruesos superiores a 18 mm.



- 1 - Tapa acero inoxidable de Ø 120 mm
- 2 - Tornillos en acero inoxidable AISI 304
- 3 - Aro de sujeción superior en ABS
- 4 - Junta NBR 90° superflexible
- 5 - Sifón desmontable
- 6 - Cuerpo base en ABS
- 7 - Junta cónica Ø 40
- 8 - Rosca 1" 1/2 G
- 9 - Racor encolable

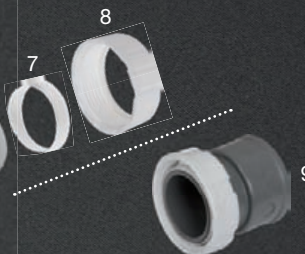

Retirando el tapón de evacuación se accede fácilmente al conducto del desagüe.



Cuerpo extraordinariamente bajo, perfecto para reformas.



Junta recambio

· Junta NBR 90° superflexible que se adapta a las posibles imperfecciones del plato de ducha

Ref.	Embalaje	Uds.	Precio u.
60002	Bolsa	5 u.	3,507 €



Válvula extraplana para plato de ducha con orificio 90 mm

· Fabricada en ABS · Tapa en acero inoxidable

Ref.	Embalaje	Uds.	Precio u.
6000	Caja transparente	4 u.	33,900 €



Válvula extraplana para plato de ducha con orificio de 90 mm

· Fabricada en ABS

Ref.	Embalaje	Uds.	Precio u.
6095	Caja	4 u.	32,900 €
60951	Skin	4 u.	33,900 €



Válvula extraplana para plato de ducha con orificio de 90 mm

· Fabricada en ABS · Aro para instalación sin tapa

Ref.	Producto	Embalaje	Uds.	Precio u.
6050	Con racor	Caja	4 u.	30,900 €
60501	Con racor	Skin	4 u.	32,500 €
6025	Sin racor	Caja	4 u.	29,900 €
60251	Sin racor	Skin	4 u.	30,900 €



Válvula extraplana para plato de ducha con orificio de 90 mm

· Fabricada en ABS · Incluye aro para instalación sin tapa

Ref.	Producto	Embalaje	Uds.	Precio u.
6075	Con racor	Caja	4 u.	36,900 €
60751	Con racor	Skin	4 u.	37,900 €
6085	Sin racor	Caja	4 u.	35,900 €
60851	Sin racor	Skin	4 u.	36,900 €

1



Válvula para plato de ducha

· Para plato de ducha con orificio Ø 50 mm · Cuerpo fabricado en latón DIN 17 660 · Ala de 80 mm en latón cromado · Registrable

Ref.	Embalaje	Uds.	Precio u.
3297	Caja	4 u.	28,950 €



Sumidero roscado

· Fabricado en latón DIN 17 660 cromado · Rosca 1" 1/4 G.

Ref.	Embalaje	Uds.	Precio u.
8023	Caja	6 u.	19,664 €



Para instalaciones horizontales o verticales

Sumidero con codo

· Fabricado en latón DIN 17 660 cromado

Ref.	Embalaje	Uds.	Precio u.
8615	Caja	4 u.	26,500 €

Sumidero con racor

· Fabricado en latón DIN 17 660 cromado

Ref.	Embalaje	Uds.	Precio u.
8600	Caja	6 u.	22,255 €



Conjunto completo para bañera

· Cuerpo fabricado en latón DIN 17 660 · Conexión de 670 mm reforzada

Ref.	Producto	Embalaje	Uds.	Precio u.
3203	Conjunto completo	Bolsa	1 u.	45,880 €
32031	Conjunto completo	Caja	1 u.	47,120 €
3225	Tapón + cadena	Bolsa ind.	20 u.	2,755 €



Desagüe automático para bañera

· Válvula click-clack incorporada · Cuerpo en latón DIN 17 660
· Tubo de cobre flexible y extensible de 45 cm. a 55 cm.

Ref.	Embalaje	Uds.	Precio u.
6839	Caja	1 u.	51,520 €

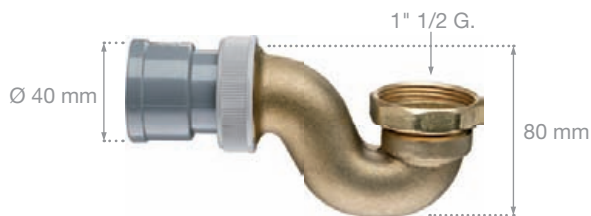

Sifón para desagüe automático de bañera

· Cuerpo fabricado en latón DIN 17 660

Ref.	Producto	Embalaje	Uds.	Precio u.
8801	Sifón con racor	Bolsa ind.	1 u.	17,500 €
8800	Sifón sin racor	Bolsa ind.	1 u.	16,250 €



Conjunto para desagüe automático de bañera

· Fabricado en latón cromado

Ref.	Embalaje	Uds.	Precio u.
6840	Bolsa	1 u.	21,505 €

Canaletas para ducha

Fabricada completamente en acero inoxidable AISI 304 según norma DIN 1.4301.

Su diseño y fabricación le permite soportar una resistencia de carga clase K3 según las especificaciones de la norma UNE EN 1253.

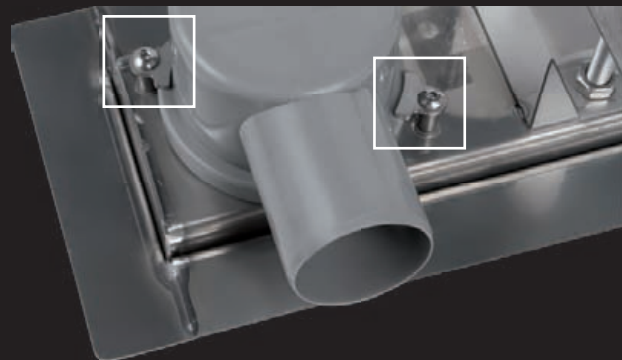

Todas las canaletas incorporan un sistema de fijación de seguridad para la válvula de desagüe.

Canaleta 700 mm

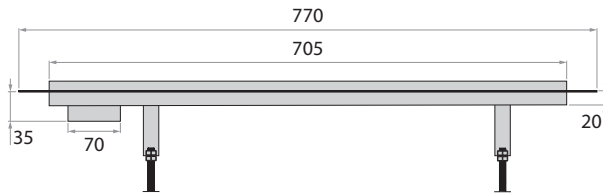

Canaleta 800 mm

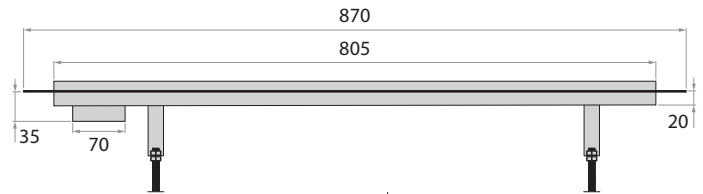

Canaleta 700/800 mm

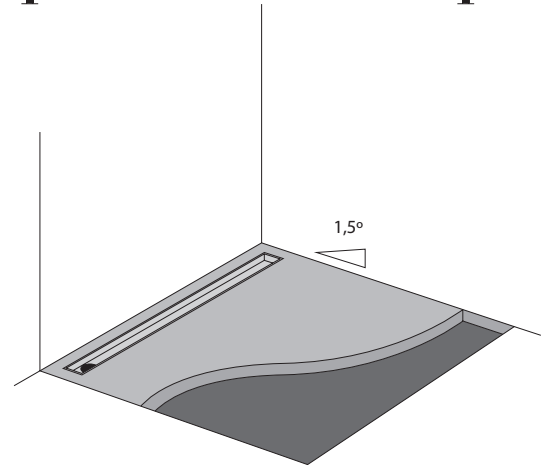
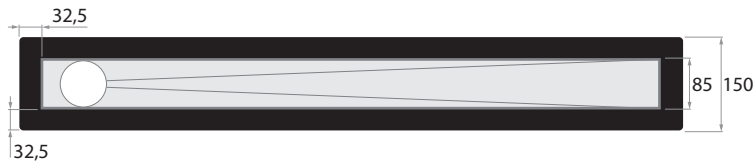

Canaleta 700/800 mm

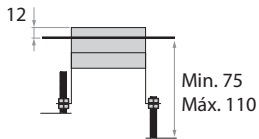

Para su instalación, se recomienda una inclinación del suelo de 1,5° para obtener un drenaje óptimo



Canaleta base 700 mm

· Fabricada en acero inoxidable AISI 304

Ref.	Embalaje	Uds.	Precio u.
1010	Caja	1 u.	192,850 €

Canaleta base 800 mm

· Fabricada en acero inoxidable AISI 304

Ref.	Embalaje	Uds.	Precio u.
1050	Caja	1 u.	197,750 €

1

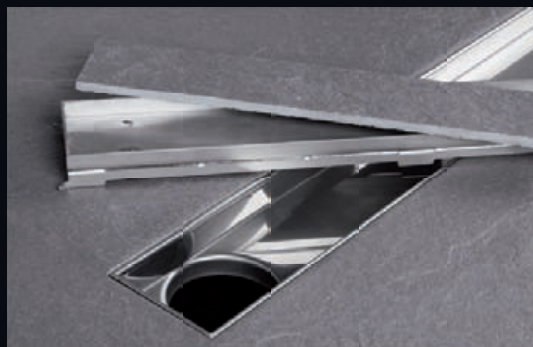

Medidas de relleno:

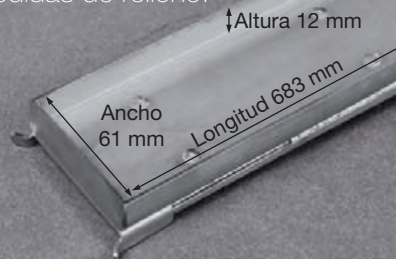

Canaleta Flat
con rejilla rellenable para
conseguir un acabado
homogéneo con el resto
del suelo de la ducha.



Canaleta Flat 700 mm con válvula 75 mm
 · Fabricada en acero inoxidable AISI 304 · Válvula de 75 mm con salida a desagüe de Ø 50 mm

Ref.	Producto	Embalaje	Uds.	Precio u.
1250	Sin lámina Kerdi	Caja	1u.	295,250 €
12502	Con lámina Kerdi	Caja	1u.	320,500 €



Canaleta Flat 800 mm con válvula 75 mm
 · Fabricada en acero inoxidable AISI 304 · Válvula de 75 mm con salida a desagüe de Ø 50 mm

Ref.	Producto	Embalaje	Uds.	Precio u.
1260	Sin lámina Kerdi	Caja	1u.	313,500 €
12602	Con lámina Kerdi	Caja	1u.	338,500 €



Canaleta Flat 700 mm con válvula 65 mm
 · Fabricada en acero inoxidable AISI 304 · Válvula de 65 mm con salida a desagüe de Ø 50 mm

Ref.	Producto	Embalaje	Uds.	Precio u.
1255	Sin lámina Kerdi	Caja	1u.	295,250 €
12552	Con lámina Kerdi	Caja	1u.	320,500 €



Canaleta Flat 800 mm con válvula 65 mm
 · Fabricada en acero inoxidable AISI 304 · Válvula de 65 mm con salida a desagüe de Ø 50 mm

Ref.	Producto	Embalaje	Uds.	Precio u.
1265	Sin lámina Kerdi	Caja	1u.	313,500 €
12652	Con lámina Kerdi	Caja	1u.	338,500 €

1

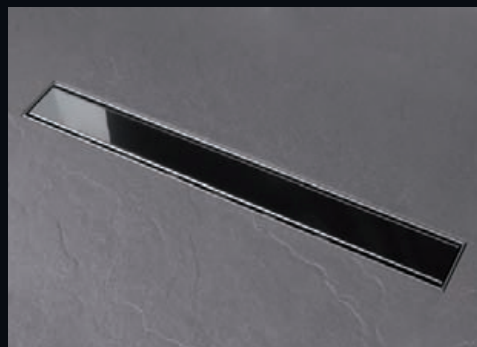

Canaleta
Brillance



Canaleta Brillance 700 mm con válvula 75 mm
 · Fabricada en acero inoxidable AISI 304 · Válvula de 75 mm con salida a desagüe de Ø 50 mm

Ref.	Producto	Embalaje	Uds.	Precio u.
1270	Sin lámina Kerdi	Caja	1u.	275,500 €
12702	Con lámina Kerdi	Caja	1u.	299,750 €

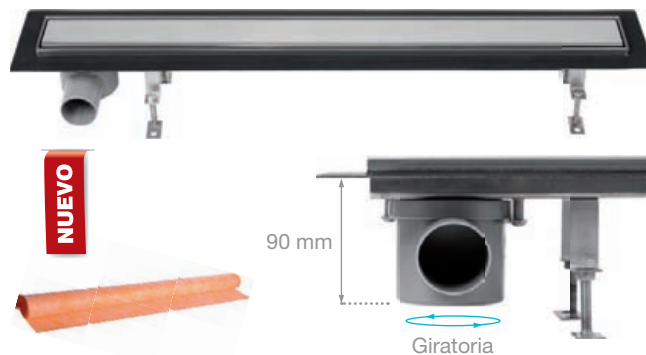

Canaleta Brillance 800 mm con válvula 75 mm
 · Fabricada en acero inoxidable AISI 304 · Válvula de 75 mm con salida a desagüe de Ø 50 mm

Ref.	Producto	Embalaje	Uds.	Precio u.
1280	Sin lámina Kerdi	Caja	1u.	295,750 €
12802	Con lámina Kerdi	Caja	1u.	322,750 €



Canaleta Brillance 700 mm con válvula 65 mm
 · Fabricada en acero inoxidable AISI 304 · Válvula de 65 mm con salida a desagüe de Ø 50 mm

Ref.	Producto	Embalaje	Uds.	Precio u.
1275	Sin lámina Kerdi	Caja	1u.	275,500 €
12752	Con lámina Kerdi	Caja	1u.	299,750 €



Canaleta Brillance 800 mm con válvula 65 mm
 · Fabricada en acero inoxidable AISI 304 · Válvula de 65 mm con salida a desagüe de Ø 50 mm

Ref.	Producto	Embalaje	Uds.	Precio u.
1285	Sin lámina Kerdi	Caja	1u.	295,750 €
12852	Con lámina Kerdi	Caja	1u.	322,750 €

1

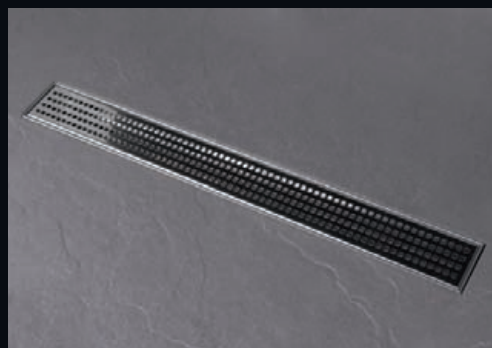

Canaleta
Quadro



Canaleta Quadro 700 mm con válvula 75 mm
 · Fabricada en acero inoxidable AISI 304 · Válvula de 75 mm con salida a desagüe de Ø 50 mm

Ref.	Producto	Embalaje	Uds.	Precio u.
1015	Sin lámina Kerdi	Caja	1u.	285,750 €
10152	Con lámina Kerdi	Caja	1u.	310,500 €

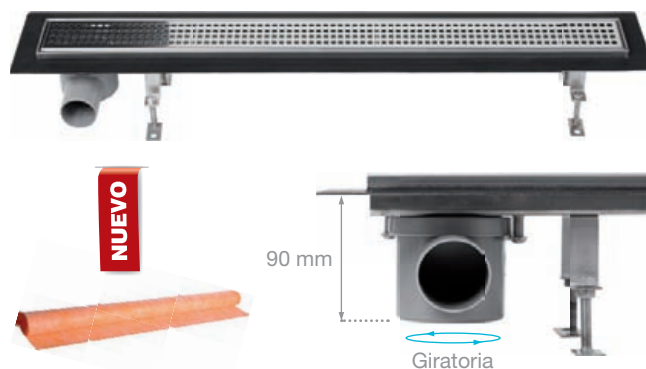

Canaleta Quadro 800 mm con válvula 75 mm
 · Fabricada en acero inoxidable AISI 304 · Válvula de 75 mm con salida a desagüe de Ø 50 mm

Ref.	Producto	Embalaje	Uds.	Precio u.
1110	Sin lámina Kerdi	Caja	1u.	304,900 €
11102	Con lámina Kerdi	Caja	1u.	339,900 €



Canaleta Quadro 700 mm con válvula 65 mm
 · Fabricada en acero inoxidable AISI 304 · Válvula de 65 mm con salida a desagüe de Ø 50 mm

Ref.	Producto	Embalaje	Uds.	Precio u.
1017	Sin lámina Kerdi	Caja	1u.	285,750 €
10172	Con lámina Kerdi	Caja	1u.	310,500 €



Canaleta Quadro 800 mm con válvula 65 mm
 · Fabricada en acero inoxidable AISI 304 · Válvula de 65 mm con salida a desagüe de Ø 50 mm

Ref.	Producto	Embalaje	Uds.	Precio u.
1122	Sin lámina Kerdi	Caja	1u.	304,900 €
11222	Con lámina Kerdi	Caja	1u.	339,900 €

NUEVO



Rejilla recambio Flat para rellenar

· Fabricada en acero inoxidable

Ref.	Producto	Embalaje	Uds.	Precio u.
1140	Para canaleta 700 mm	Caja	1 u.	92,500 €
1150	Para canaleta 800 mm	Caja	1 u.	104,750 €

NUEVO



Rejilla recambio Quadro

· Fabricada en acero inoxidable

Ref.	Producto	Embalaje	Uds.	Precio u.
1100	Para canaleta 700 mm	Caja	1 u.	85,750 €
1112	Para canaleta 800 mm	Caja	1 u.	96,250 €

NUEVO



Rejilla recambio Brillance

· Fabricada en acero inoxidable

Ref.	Producto	Embalaje	Uds.	Precio u.
1120	Para canaleta 700 mm	Caja	1 u.	76,750 €
1130	Para canaleta 800 mm	Caja	1 u.	89,500 €

NUEVO



Lámina geotéxtil Kerdi

Ref.	Medida	Embalaje	Uds.	Precio u.
1190	100 cm x 100 cm	Caja	1 u.	26,950 €
1192	100 cm x 150 cm	Caja	1 u.	39,750 €

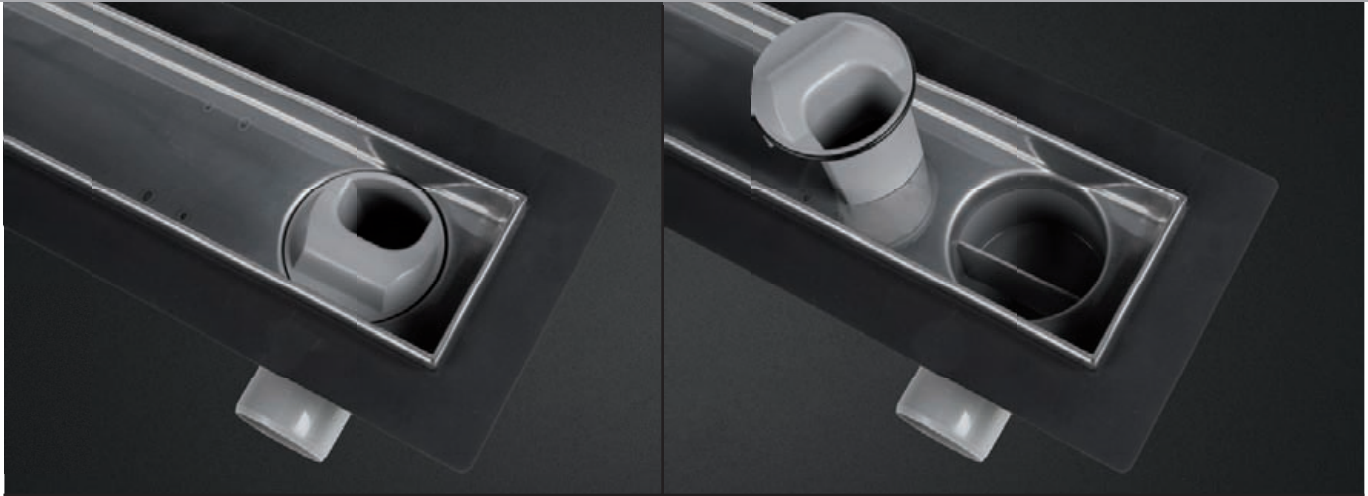

Las válvulas para canaleta ofrecen un rápido acceso al interior de la misma mediante el bote sifónico desmontable

NUEVO



75 mm

Válvula 75 mm para canaleta DN 50 mm

- Fabricada en ABS · Bote sifónico desmontable · Caudal 48 lit/min
- Desagüe según norma EN 274

Ref.	Embalaje	Uds.	Precio u.
1200	Bolsa	1 u.	15,500 €

NUEVO



65 mm

Válvula 65 mm para canaleta DN 50 mm

- Fabricada en ABS · Bote sifónico desmontable · Caudal 48 lit/min

Ref.	Embalaje	Uds.	Precio u.
1210	Bolsa	1 u.	14,255 €





2



ACERO INOXIDABLE

Válvula con rebosadero redondo para fregadero

· Cazoleta en acero inoxidable AISI 304 pulido

Ref.	Embalaje	Uds.	Precio u.
3402	Bolsa ind.	12 u.	11,500 €
34021	Skin	12 u.	12,100 €



ACERO INOXIDABLE

Válvula con rebosadero rectangular para fregadero

· Cazoleta en acero inoxidable AISI 304 pulido

Ref.	Embalaje	Uds.	Precio u.
3408	Bolsa ind.	12 u.	12,250 €
34081	Skin	12 u.	12,850 €



ACERO INOXIDABLE

Válvula con rebosadero redondo y rectangular para fregadero

· Cazoleta en acero inoxidable AISI 304 pulido

Ref.	Embalaje	Uds.	Precio u.
3405	Bolsa ind.	12 u.	13,950 €
34051	Skin	12 u.	14,550 €



ACERO INOXIDABLE

Válvula sin rebosadero para fregadero

· Cazoleta en acero inoxidable AISI 304 pulido

Ref.	Embalaje	Uds.	Precio u.
3783	Bolsa ind.	18 u.	9,505 €
37831	Skin	18 u.	10,105 €



Válvula con rebosadero redondo para fregadero

· Color blanco

Ref.	Embalaje	Uds.	Precio u.
3403	Bolsa ind.	12 u.	10,505 €
34031	Skin	12 u.	11,105 €



Válvula sin rebosadero para fregadero

· Color blanco

Ref.	Embalaje	Uds.	Precio u.
3517	Bolsa ind.	18 u.	7,910 €
35171	Skin	18 u.	8,510 €

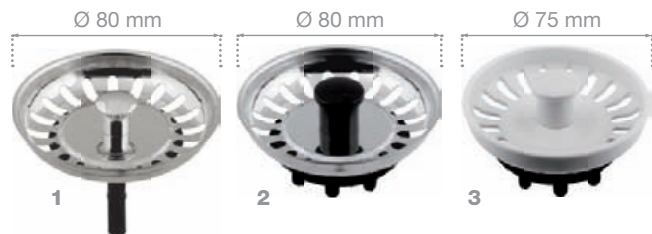

Tapones para válvula de fregadero

Ref.	Producto	Embalaje	Uds.	Precio u.
3950	1 - Inox con espiga	Bolsa	15 u.	3,890 €
39501	1 - Inox con espiga	Skin	12 u.	4,490 €
3916	2 - Inox	Bolsa	15 u.	3,890 €
39161	2 - Inox	Skin	12 u.	4,490 €
3540	3 - Blanca	Bolsa	15 u.	3,890 €
35401	3 - Blanca	Skin	12 u.	4,490 €



Juntas recambio para válvula de fregadero

· Ø 115 mm

Ref.	Producto	Embalaje	Uds.	Precio u.
3411	1 - Junta superior	Caja	25 u.	0,757 €
3412	2 - Junta inferior	Caja	25 u.	0,859 €

Junta soldada al cuerpo



Válvula para lavabo y fregadero

· Cazoleta inox AISI 304 acabado cromado de Ø 70 mm. · Rosca interior en latón · Tapón en latón cromado · Cadena en latón cromado de 30 cm. de longitud

Ref.	Medida	Embalaje	Uds.	Precio u.
7915	Ø 30 mm	Caja	10 u.	10,985 €
8370	Ø 35 mm	Caja	10 u.	10,985 €
7916	Ø 38 mm	Caja	10 u.	10,985 €

Junta soldada al cuerpo



Válvula para lavabo y fregadero

· Cazoleta inox AISI 304 pulido de Ø 70 mm. · Rosca interior en latón · Tapón en goma remachado · Cadena en latón cromado de 30 cm. de longitud

Ref.	Medida	Embalaje	Uds.	Precio u.
2411	Ø 30 mm	Caja	10 u.	3,945 €
2412	Ø 35 mm	Caja	10 u.	3,945 €
2413	Ø 38 mm	Caja	10 u.	3,945 €

Junta soldada al cuerpo



Válvula para lavabo y fregadero

· Cazoleta inox AISI 304 pulido · Rosca interior en latón · Tapón en goma remachado

Ref.	Medida	Embalaje	Uds.	Precio u.
2611	Ø 30 mm	Bolsa	15 u.	2,823 €
3317	Ø 35 mm	Bolsa	15 u.	2,823 €
2612	Ø 38 mm	Bolsa	15 u.	2,823 €



Válvula para fregadero

· Cazoleta acero inoxidable AISI 304 pulido · 1" 1/2 G. x Ø 70 mm · Tapón en goma remachado

Ref.	Embalaje	Uds.	Precio u.
3810	Bolsa	10 u.	2,535 €



Válvula para fregadero

· Cazoleta inoxi AISI 304 cromado de Ø 70 mm · Tapón en latón cromado · Cadena latón cromado de 30 cm de longitud

Ref.	Embalaje	Uds.	Precio u.
8750	Caja	10 u.	10,985 €



Tapón de goma

· Para válvula lavabo/fregadero · Remachado en latón

Ref.	Producto	Embalaje	Uds.	Precio u.
3015	1 - Universal Ø 47 mm	Bolsa	25 u.	0,691 €
3779	2 - Lavabos Teka / Roca	Bolsa	25 u.	1,395 €



Cadena completa

· Fabricada en latón cromado

Ref.	Producto	Embalaje	Uds.	Precio u.
6994	1 - Cadena 30 cm	Caja	50 u.	1,075 €
1912	1 - Cadena 45 cm	Caja	50 u.	1,295 €
7004	2 - Anilla	Caja	100 u.	0,100 €
7005	3 - Enganche	Caja	100 u.	0,085 €



Tomillo recambio

· Para válvula lavabo/fregadero · Fabricado en acero inoxidable

Ref.	Medida	Embalaje	Uds.	Precio u.
3920	M6 x 60 mm	Caja	25 u.	0,735 €
3922	M6 x 75 mm	Caja	25 u.	0,855 €



Sifón de goma abierto en Skin

Sifón de goma abierto en bolsa individual

Sifón de goma abierto a granel

Ref.	Medida	Uds.	Precio u.
31032	25 x 30 mm	24 u.	3,120 €
31042	30 x 30 mm	24 u.	3,120 €
31052	35 x 35 mm	24 u.	3,120 €
31062	35 x 40 mm	24 u.	3,120 €
31812	40 x 40 mm	24 u.	3,205 €

Ref.	Medida	Uds.	Precio u.
31031	25 x 30 mm	28 u.	2,795 €
31041	30 x 30 mm	28 u.	2,795 €
31051	35 x 35 mm	28 u.	2,795 €
31061	35 x 40 mm	28 u.	2,795 €
31811	40 x 40 mm	25 u.	2,852 €

Ref.	Medida	Uds.	Precio u.
3103	25 x 30 mm	30 u.	2,295 €
3104	30 x 30 mm	30 u.	2,295 €
3105	35 x 35 mm	30 u.	2,295 €
3106	35 x 40 mm	30 u.	2,295 €
3181	40 x 40 mm	30 u.	2,429 €



Sifón de goma cerrado en Skin

Sifón de goma cerrado en bolsa individual

Sifón de goma cerrado a granel

Ref.	Medida	Uds.	Precio u.
31072	25 x 30 mm	25 u.	3,695 €
31082	30 x 30 mm	25 u.	3,695 €
31092	35 x 35 mm	25 u.	3,695 €
31102	40 x 40 mm	25 u.	3,743 €

Ref.	Medida	Uds.	Precio u.
31071	25 x 30 mm	25 u.	3,315 €
31081	30 x 30 mm	25 u.	3,315 €
31091	35 x 35 mm	25 u.	3,315 €
31101	40 x 40 mm	25 u.	3,315 €

Ref.	Medida	Uds.	Precio u.
3107	25 x 30 mm	30 u.	2,839 €
3108	30 x 30 mm	30 u.	2,839 €
3109	35 x 35 mm	30 u.	2,839 €
3110	40 x 40 mm	28 u.	2,839 €

En ABS para encolar



En ABS para encolar



Manguito extensible blanco

· Extensible de 300 a 800 mm · Fabricado en polipropileno copolímero

Ref.	Producto	Embalaje	Uds.	Precio u.
7500	1" 1/4 G. x 32/40 mm	Bolsa ind.	4 u.	3,838 €
7600	1" 1/2 G. x 40 mm	Bolsa ind.	4 u.	3,838 €
75001	1" 1/4 G. x 32/40 mm	Skin	4 u.	4,438 €
76001	1" 1/2 G. x 40 mm	Skin	4 u.	4,438 €

En ABS para encolar



En ABS para encolar



Manguito extensible cromado

· Extensible de 300 a 800 mm · Florón en ABS cromado incluido
· Fabricado en polipropileno copolímero

Ref.	Producto	Embalaje	Uds.	Precio u.
7400	1" 1/4 G. x 32/40 mm	Bolsa ind.	4 u.	6,820 €
74001	1" 1/4 G. x 32/40 mm	Skin	4 u.	7,420 €

Toma para lavavajillas



Sifón completo para fregadero

· Fabricado en goma · Entradas de 35 mm y salida de 40 mm
· De centro a centro de las entradas: 26 cm. hasta 36 cm.

Ref.	Embalaje	Uds.	Precio u.
4047	Bolsa ind.	20 u.	9,751 €
40471	Skin	12 u.	10,252 €



Junta EPDM incluida



Racor reductor

· Adaptable a todos los modelos de fregadero · Indicado para sifones de goma

Ref.	Producto	Embalaje	Uds.	Precio u.
3289	1" 1/2 G. x 35 mm	Caja	30 u.	1,235 €
3290	1" 1/4 G. x 35 mm	Caja	30 u.	1,235 €
32891	1" 1/2 G. x 35 mm	Skin	30 u.	1,635 €
32901	1" 1/4 G. x 35 mm	Skin	30 u.	1,635 €



3



HIGH
LINE



50%
DE AHORRO
DE AGUA



Cabezal
Ø 100 mm



Mango de ducha io

- Función lluvia fina · Sistema inteligente de distribución del agua
- Sistema de ahorro de agua · Anticalcáreo · Fabricado en una sola pieza en ABS

Ref.	Embalaje	Uds.	Precio u.
9825	Caja	2 u.	18,500 €



50%
DE AHORRO
DE AGUA



Cabezal
Ø 90 mm

Masaje
intermitente

Lluvia

Lluvia +
masaje

Aire con
agua

Lluvia +
aire con
agua



Mango de ducha Galaxy

- Cinco funciones · Sistema de ahorro de agua · Anticalcáreo
- Fabricado en ABS

Ref.	Embalaje	Uds.	Precio u.
7690	Caja	2 u.	24,750 €



50%
DE AHORRO
DE AGUA



Cabezal
Ø 135 mm



ANTICAL



LIMPIAFÁCIL

Mango de ducha Colors

- Función lluvia fina · Sistema de ahorro de agua · Anticalcáreo
- Sistema de iluminación alimentado por la presión del agua
- Fabricado en ABS

Ref.	Embalaje	Uds.	Precio u.
9925	Caja	1 u.	39,905 €

Indicación de la temperatura del agua mediante iluminación led

Iluminación azul:
Temperatura inferior a 32°

Iluminación roja intermitente:
Temperatura superior a 38°

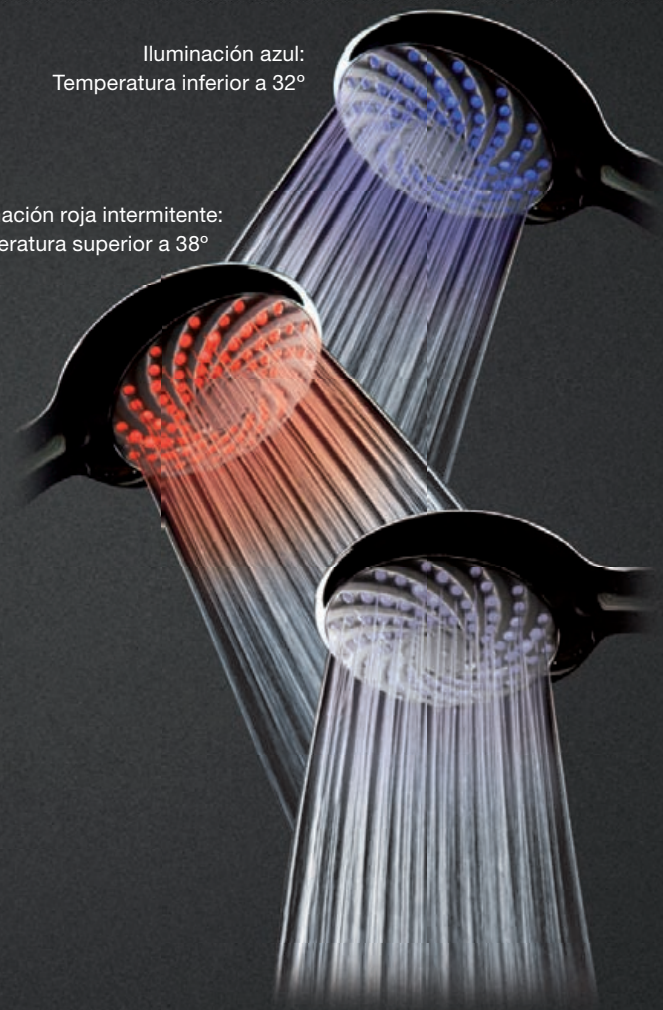

Iluminación blanca:
Temperatura entre 32° y 38°

3

3



50%
DE AHORRO
DE AGUA



Kit lo completo

· Compuesto por ducha lo, flexo 9000 y soporte ajustable

Ref.	Embalaje	Uds.	Precio u.
9025	Caja	1 u.	42,950 €



50%
DE AHORRO
DE AGUA

Kit lo básico

· Compuesto por ducha lo y flexo 9000

Ref.	Embalaje	Uds.	Precio u.
9050	Caja	1 u.	36,500 €



50%
DE AHORRO
DE AGUA

Kit Sun 9000 completo

· Compuesto por ducha Sun, flexo 9000 y soporte ajustable

Ref.	Embalaje	Uds.	Precio u.
9880	Caja	1 u.	42,500 €

50%
DE AHORRO
DE AGUA

Kit Sun inox completo

· Compuesto por ducha Sun, flexo inox y soporte ajustable

Ref.	Embalaje	Uds.	Precio u.
9895	Caja	1 u.	31,250 €



3

3



**50%
DE AHORRO
DE AGUA**



Kit Sun 9000 básico

· Compuesto por ducha Sun y flexo 9000

Ref.	Embalaje	Uds.	Precio u.
9875	Caja	1 u.	37,750 €



**50%
DE AHORRO
DE AGUA**

Kit Sun inox básico

· Compuesto por ducha Sun y flexo inox

Ref.	Embalaje	Uds.	Precio u.
9890	Caja	1 u.	26,950 €



Kit Desiree completo

· Compuesto por ducha Desiree, flexo inox y soporte ajustable

Ref.	Embalaje	Uds.	Precio u.
8850	Caja	1 u.	22,250 €

Kit Desiree básico

· Compuesto por ducha Desiree y flexo inox

Ref.	Embalaje	Uds.	Precio u.
8875	Caja	1 u.	18,500 €



PREMIUM LINE

3



Masaje intermitente

Lluvia

Lluvia con masaje



Masaje intermitente

Lluvia

Lluvia con masaje



Mango de ducha Univers

- Tres funciones · Sistema de ahorro de agua · Anticalcáreo
- Fabricado en ABS

Ref.	Embalaje	Uds.	Precio u.
9600	Caja	4 u.	23,900 €



Mango de ducha Sun

- Tres funciones · Sistema de ahorro de agua · Anticalcáreo
- Fabricado en ABS

Ref.	Embalaje	Uds.	Precio u.
9850	Caja	4 u.	19,900 €

50%
DE AHORRO
DE AGUA

Cabezal
Ø 75 mm



Masaje
intermitente

Lluvia
1 anillo

Lluvia
2 anillos



Mango de ducha Uliani

- Tres funciones · Sistema de ahorro de agua · Anticalcáreo
- Fabricado en ABS

Ref.	Embalaje	Uds.	Precio u.
9800	Caja	4 u.	16,500 €

50%
DE AHORRO
DE AGUA

Cabezal
Ø 70 mm



Lluvia



Mango de ducha Athena ahorro de agua

- Sistema de ahorro de agua · Anticalcáreo · Fabricado en ABS

Ref.	Embalaje	Uds.	Precio u.
7615	Caja	4 u.	10,750 €

3

3



Ducha Sun x 15
 PVP normal: ~~19,900 €~~
 PVP en expositor: 17,670 €



Ducha lo x 30
 PVP normal: ~~18,500 €~~
 PVP en expositor: 16,000 €

Expositor Sun

· Compuesto por 15 uds. ducha Sun

Ref.	Embalaje	Uds.	Precio u.
100875	Caja	1 u.	265,000 €

Expositor lo

· Compuesto por 30 uds. ducha lo

Ref.	Embalaje	Uds.	Precio u.
100900	Caja	1 u.	480,000 €



Ducha Colors x 10
 PVP normal: ~~39,905 €~~
 PVP en expositor: 38,500 €



Ducha lo x 10
 PVP normal: ~~18,500 €~~
 PVP en expositor: 16,000 €



Ducha Sun x 5
 PVP normal: ~~19,900 €~~
 PVP en expositor: 17,670 €



Ducha Colors x 5
 PVP normal: ~~39,905 €~~
 PVP en expositor: 38,500 €

Expositor Colors

· Compuesto por 10 uds. de ducha Colors

Ref.	Embalaje	Uds.	Precio u.
100325	Caja	1 u.	385,000 €

Expositor Multiduchas

· Compuesto por 10 uds. de ducha lo, 5 uds. de ducha Sun y 5 uds. de ducha Colors

Ref.	Embalaje	Uds.	Precio u.
100800	Caja	1 u.	440,850 €



Ducha lo x 10

PVP normal: ~~18,500 €~~
PVP en expositor: 16,000 €



Ducha Sun x 10

PVP normal: ~~19,900 €~~
PVP en expositor: 17,670 €



Ducha Galaxy x 9

PVP normal: ~~24,750 €~~
PVP en expositor: 22,500 €

Expositor Sun + lo

· Compuesto por 10 uds. de ducha Sun y 10 uds. de ducha lo

Ref.	Embalaje	Uds.	Precio u.
100950	Caja	1 u.	336,700 €

Expositor Galaxy

· Compuesto por 9 uds. de ducha Galaxy

Ref.	Embalaje	Uds.	Precio u.
103100	Caja	1 u.	202,500 €



NUEVO

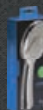

Ducha Univers x 5

PVP normal: ~~23,900 €~~
PVP en expositor: 21,670 €



Ducha Sun x 5

PVP normal: ~~19,900 €~~
PVP en expositor: 17,670 €



Ducha Colors x 5

PVP normal: ~~39,905 €~~
PVP en expositor: 38,500 €

Expositor Multiduchas

· Compuesto por 5 uds. de ducha Univers, 5 uds. de ducha Sun y 5 uds. de ducha Colors

Ref.	Embalaje	Uds.	Precio u.
100575	Caja	1 u.	389,200 €



NUEVO



Ducha Univers x 15

PVP normal: ~~23,900 €~~
PVP en expositor: 21,670 €

Expositor Univers

· Compuesto por 15 uds. de ducha Univers

Ref.	Embalaje	Uds.	Precio u.
100725	Caja	1 u.	326,000 €

3



Ducha Desiree x 9
 PVP normal: ~~11,900 €~~
 PVP en expositor: 11,000 €



Ducha Ulani x 5
 PVP normal: ~~16,500 €~~
 PVP en expositor: 15,900 €

Ducha Athena x 5
 PVP normal: ~~10,750 €~~
 PVP en expositor: 10,250 €

Expositor Desiree

· Compuesto por 9 uds. de ducha Desiree

Ref.	Embalaje	Uds.	Precio u.
103200	Caja	1 u.	99,000 €

Expositor Ulani + Athena

· Compuesto por 5 uds. de ducha Athena y 5 uds. de ducha Ulani

Ref.	Embalaje	Uds.	Precio u.
100600	Caja	1 u.	130,750 €



Ducha Athena x 10
 PVP normal: ~~10,750 €~~
 PVP en expositor: 10,250 €



Ducha Ulani x 10
 PVP normal: ~~16,500 €~~
 PVP en expositor: 15,900 €

Expositor Athena

· Compuesto por 10 uds. de ducha Athena

Ref.	Embalaje	Uds.	Precio u.
100400	Caja	1 u.	102,500 €

Expositor Ulani

· Compuesto por 10 uds. de ducha Ulani

Ref.	Embalaje	Uds.	Precio u.
100500	Caja	1 u.	159,000 €



BASIC



Mango de ducha Athena

· Anticalcáreo · Función lluvia fina · Fabricado en ABS

Ref.	Acabado	Embalaje	Uds.	Precio u.
7611	Cromado	Skin	6 u.	8,250 €
8500	Blanco	Skin	6 u.	7,825 €



Mango de ducha Zoé

· Anticalcáreo · Función lluvia fina · Diseño minimalista · Fabricado en ABS

Ref.	Embalaje	Uds.	Precio u.
3200	Skin	4 u.	11,250 €



Mango de ducha Desiree

· Anticalcáreo · Tres funciones · Fabricado en ABS

Ref.	Embalaje	Uds.	Precio u.
8810	Caja	4 u.	11,900 €



Mango de ducha con cierre

· Función lluvia fina · Codo en ABS incorporado · Fabricado en polipropileno

Ref.	Embalaje	Uds.	Precio u.
1164	Skin	2 u.	10,911 €



Mango de ducha Gales

· Función lluvia fina · Codo incorporado · Fabricado en polipropileno

Ref.	Producto	Embalaje	Uds.	Precio u.
3674	Blanco con codo ABS	Skin	10 u.	2,975 €
3968	Blanco con codo latón	Skin	10 u.	7,779 €
3675	Negro con codo ABS	Skin	10 u.	2,975 €
3969	Negro con codo latón	Skin	10 u.	7,779 €



Mango de ducha baja presión

· Función lluvia gruesa · Anticalcáreo · Fabricado en polipropileno

Ref.	Producto	Embalaje	Uds.	Precio u.
1154	Blanco con codo ABS	Skin	10 u.	3,595 €
8840	Blanco con codo latón	Skin	10 u.	7,290 €
1156	Negro con codo ABS	Skin	10 u.	3,595 €
8841	Negro con codo latón	Skin	10 u.	7,290 €



Mango de ducha Diana

· Función lluvia fina · Codo en ABS incorporado · Fabricado en polipropileno

Ref.	Acabado	Embalaje	Uds.	Precio u.
1114	Blanco	Bolsa	15 u.	2,841 €
1116	Negro	Bolsa	15 u.	2,841 €



Codos para mangos de ducha

· Rosca 1/2" G.

Ref.	Producto	Embalaje	Uds.	Precio u.
2111	1 - Latón fijo	Bolsa	6 u.	3,945 €
2112	2 - ABS fijo	Bolsa	6 u.	0,955 €
2113	3 - Giratorio	Bolsa	6 u.	6,595 €



Fabricado en una sola pieza

Fabricado en una sola pieza

SopORTE ajustable para mangos de ducha

· Fabricado en ABS · Incluye tacos y tornillos

Ref.	Acabado	Embalaje	Uds.	Precio u.
2324	Cromado	Bolsa	10 u.	5,105 €
23241	Cromado	Skin	10 u.	5,705 €
2328	Blanco	Bolsa	10 u.	4,190 €
23281	Blanco	Skin	10 u.	4,823 €

SopORTE ajustable Zoé

· Fabricado en ABS · Incluye tacos y tornillos

Ref.	Embalaje	Uds.	Precio u.
3201	Skin	4 u.	7,250 €



ACERO INOXIDABLE

SopORTE fijo para mangos de ducha

· Fabricado en ABS · Incluye tacos y tornillos

Ref.	Acabado	Embalaje	Uds.	Precio u.
2334	Cromado	Bolsa	6 u.	2,726 €
23341	Cromado	Skin	6 u.	3,326 €
2336	Blanco	Bolsa	6 u.	2,546 €
23361	Blanco	Skin	6 u.	3,146 €

SopORTE con rótula

· Rótula orientable · Fabricado en acero inoxidable · Florón en acero inoxidable · Incluye tacos y tornillos

Ref.	Embalaje	Uds.	Precio u.
2311	Bolsa	4 u.	4,416 €
23111	Skin	4 u.	5,031 €



3

Soporte roscado con rótula y toma de agua

· Fabricado en latón cromado · Con toma de agua 1/2" G. · Rótula orientable

Ref.	Embalaje	Uds.	Precio u.
2313	Bolsa	1 u.	18,312 €
23131	Skin	1 u.	18,912 €

Soporte con toma de agua

· Fabricado en latón cromado · Con toma de agua 1/2" G.

Ref.	Embalaje	Uds.	Precio u.
5445	Caja	1 u.	33,900 €
54451	Skin	1 u.	34,500 €



Soporte roscado toma de agua

· Roscas 1/2" G. x 1/2 G. · Fabricado en latón acabado cromado
· Incluye florón de Ø 50 mm.

Ref.	Embalaje	Uds.	Precio u.
5437	Caja	4 u.	6,815 €
54371	Skin	4 u.	7,415 €

Soporte roscado toma de agua Luxury

· Roscas 1/2" G. x 1/2 G. · Fabricado en latón acabado cromado

Ref.	Embalaje	Uds.	Precio u.
5439	Caja	2 u.	14,545 €
54391	Skin	2 u.	15,104 €

50%
DE AHORRO
DE AGUA

Cabezal
Ø 90 mm



NUEVO
DISEÑO



Aire + Agua

Lluvia

Vapor

Masaje

Rociador Galaxy

· 4 funciones · Sistema de ahorro de agua · Anticalcáreo

Ref.	Producto	Embalaje	Uds.	Precio u.
7693	Con ahorrador de agua	Caja	1 u.	22,360 €
76931	Con ahorrador de agua	Skin	1 u.	22,960 €
7692	Sin ahorrador de agua	Caja	1 u.	18,560 €
76921	Sin ahorrador de agua	Skin	1 u.	19,060 €



ANTICAL

Brazo de ducha con rociador orientable

· Sistema de ahorro de agua · Anticalcáreo · Rosca 1/2" G.
· Fabricado en latón DIN 17 660 cromado

Ref.	Producto	Embalaje	Uds.	Precio u.
3645	Con ahorrador de agua	Caja	2 u.	25,751 €
36451	Con ahorrador de agua	Skin	2 u.	26,351 €
3630	Sin ahorrador de agua	Caja	2 u.	21,965 €
36301	Sin ahorrador de agua	Skin	2 u.	22,565 €

50%
DE AHORRO
DE AGUA



ANTICAL



Rociador orientable

· Anticalcáreo · Rosca 1/2" G. · Fabricado en latón DIN 17 660 cromado

Ref.	Producto	Embalaje	Uds.	Precio u.
4829	Ahorro de agua	Bolsa ind.	12 u.	12,500 €
48291	Ahorro de agua	Skin	12 u.	13,100 €
4827	Económico	Bolsa ind.	12 u.	9,950 €
48271	Económico	Skin	12 u.	10,550 €

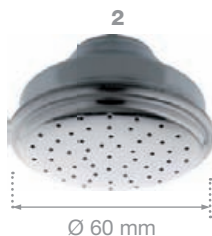

ACERO INOXIDABLE

Rociador acero inoxidable

· Rosca H 1/2" G. · Fabricado en acero inoxidable AISI 304

Ref.	Producto	Embalaje	Uds.	Precio u.
3102	1 - Ø 90 mm	Bolsa ind.	10 u.	2,975 €
31021	1 - Ø 90 mm	Skin	10 u.	3,575 €
1111	2 - Ø 60 mm	Bolsa ind.	20 u.	3,505 €
11111	2 - Ø 60 mm	Skin	20 u.	4,105 €



Rociador económico

· Fabricado en polipropileno · Rosca H 1/2" G.

Ref.	Embalaje	Uds.	Precio u.
3100	Bolsa	20 u.	0,819 €



Brazo de ducha

· Rosca 1/2" G. · Tubo de Ø 18 mm · Fabricado en latón DIN 17 660 cromado

Ref.	Producto	Embalaje	Uds.	Precio u.
3632	1 - Brazo + Rótula	Bolsa ind.	8 u.	18,500 €
36321	1 - Brazo + Rótula	Skin	8 u.	19,100 €
3694	2 - Brazo	Bolsa ind.	10 u.	10,900 €
36941	2 - Brazo	Skin	10 u.	11,500 €
6172	3 - Rótula MH 1/2" G.	Bolsa ind.	6 u.	7,950 €

NUEVO
DISEÑO

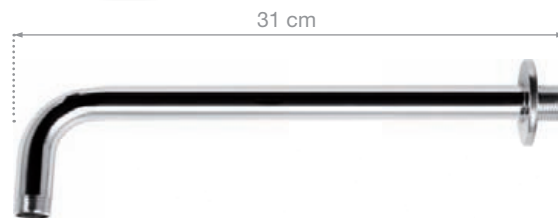

Brazo de ducha

· Rosca 1/2" G. · Tubo de Ø 20 mm · Fabricado en latón DIN 17 660 cromado

Ref.	Embalaje	Uds.	Precio u.
1101	Bolsa ind.	10 u.	7,905 €
11011	Skin	10 u.	8,505 €

Flexo de ducha 9000

3



- 1 - Tuerca giratoria que evita las torceduras en el flexo.
- 2 - Revestimiento en PVC transparente UV que protege de la cal, el moho y la suciedad.
- 3 - Tratamiento de metalización cromado para crear un efecto estético especial.
- 4 - Trenzado de 24 hilos en poliéster TIT 1000. Extraordinaria resistencia a altas temperaturas y presiones.
- 5 - Tubo interno en PVC bajo normativa NSF 61. Certificado de higiene del Instituto Pasteur de París.

Higiénico
y de fácil limpieza

Medidas y colores personalizables



Flexo de ducha plástico plata metalizado
 · Tubo de Ø 15 mm. · Tuerca latón H 1/2" G. cónica lisa alta y tuerca latón H 1/2" G. cónica lisa baja · Filtro UV · Completamente liso y fácil de limpiar · Temperatura máxima de trabajo 90° C · Presión máxima de trabajo 20 bar · Tracción 100 kg.

Ref.	Producto	Embalaje	Uds.	Precio u.
9000	1,7 mts	Caja	4 u.	18,750 €
9016	1 mts	Skin	1 u.	15,950 €





Flexo 9000 x 5

PVP normal: ~~18,750-€~~
PVP en expositor: 17,980 €



Flexo 9000 x 5

PVP normal: ~~18,750-€~~
PVP en expositor: 17,980 €



Flexo 9000 x 5

PVP normal: ~~18,750-€~~
PVP en expositor: 17,980 €



Ducha Colors x 5

PVP normal: ~~39,905-€~~
PVP en expositor: 38,500 €



Ducha Sun x 5

PVP normal: ~~19,900-€~~
PVP en expositor: 17,670 €



Ducha Io x 10

PVP normal: ~~18,500-€~~
PVP en expositor: 16,000 €

Expositor 9000 + Colors

· Compuesto por 5 uds. de flexo de ducha 9000 y 5 uds. de mango de ducha Colors

Ref.	Embalaje	Uds.	Precio u.
100975	Caja	1 u.	237,450 €

Expositor 9000 + Sun

· Compuesto por 5 uds. de flexo de ducha 9000 y 5 uds. de mango de ducha Sun

Ref.	Embalaje	Uds.	Precio u.
100100	Caja	1 u.	237,450 €

Expositor 9000 + Io

· Compuesto por 5 uds. de flexo de ducha 9000 y 10 uds. de mango de ducha Io

Ref.	Embalaje	Uds.	Precio u.
100825	Caja	1 u.	249,900 €



EXTENSIBLE

Flexo de ducha extensible latón cromado

· Extensible de 1,5 a 2 mts · Tuerca cónica H 1/2" G. y tuerca grafilada H 1/2" G. · Doble engatillado · Temperatura máx. de trabajo 60° C · Presión máx. de trabajo 12 bar · Tubo en EPDM

Ref.	Embalaje	Uds.	Precio u.
1421	Skin	12 u.	12,381 €



ACERO INOXIDABLE



EXTENSIBLE

Flexo de ducha extensible acero inoxidable

· Extensible de 1,7 a 2,25 mts · Tuerca cónica H 1/2" G. y tuerca grafilada H 1/2" G. · Doble engatillado · Temperatura máx. de trabajo 60° C · Presión máx. de trabajo 12 bar · Tubo en EPDM

Ref.	Embalaje	Uds.	Precio u.
14212	Skin	12 u.	7,297 €



Flexo de ducha estándar latón cromado

· Tuerca cónica H 1/2" G. y tuerca grafilada H 1/2" G. · Temperatura máx. de trabajo 60° C · Presión máx. de trabajo 8 bar · Tubo en EPDM

Ref.	Producto	Embalaje	Uds.	Precio u.
3960	1,7 mts	Skin	12 u.	6,695 €
3522	2 mts	Skin	12 u.	8,355 €



Flexo de ducha reforzado latón cromado

· Tuerca cónica H 1/2" G. y tuerca grafilada H 1/2" G. · Doble engatillado · Temperatura máx. de trabajo 60° C · Presión máx. de trabajo 12 bar · Tubo en EPDM

Ref.	Producto	Embalaje	Uds.	Precio u.
1413	1,5 mts	Skin	12 u.	9,433 €
3996	1,7 mts	Skin	12 u.	10,889 €
1414	2 mts	Skin	12 u.	11,892 €



Flexo de ducha reforzado latón cromado 1 mts

· 1 mts de longitud · Tuerca H 1/2" G. cónica y tuerca H 1/2" G. grafilada · Temperatura máx. de trabajo 60° C · Presión máx. de trabajo 8 bar · Tubo en EPDM

Ref.	Embalaje	Uds.	Precio u.
1408	Skin	1 u.	12,502 €



Flexo de ducha reforzado latón cromado

· Tuerca H 1/2" G. cónica y tuerca H 1/2" G. grafilada · Temperatura máx. de trabajo 60° C · Presión máx. de trabajo 12 bar · Tubo en EPDM

Ref.	Longitud	Embalaje	Uds.	Precio u.
8289	2 mts	Skin	1 u.	20,752 €
8288	1,5 mts	Skin	1 u.	17,502 €



Flexo de ducha reforzado latón acabado especial

· 1,7 mts de longitud · Tuerca H 1/2" G. cónica y tuerca H 1/2" G. grafilada · Temperatura máx. de trabajo 60° C · Presión máx. de trabajo 12 bar · Tubo en EPDM

Ref.	Producto	Embalaje	Uds.	Precio u.
1321	1 - Oro	Skin	1 u.	21,975 €
1322	2 - Bronce	Skin	1 u.	21,975 €
1323	3 - Oro viejo	Skin	1 u.	21,975 €

3



Mango de fregadero extraíble

· Dos posiciones: lluvia y aire+agua · Adaptable a la mayoría de caños

Ref.	Embalaje	Uds.	Precio u.
4789	Skin	4 u.	18,905 €
8490	Skin	4 u.	22,989 €



Flexo extraíble para fregadero en plástico plata metalizado

· 1,25 mts de longitud · Tuerca en latón cónica H 1/2" G. y rosca M 15/100 · Tubo de Ø 15 mm · Temperatura máx. de trabajo 90° C · Presión máx. de trabajo 20 bar · Incluye contrapeso de plomo

Ref.	Embalaje	Uds.	Precio u.
6905	Skin	2 u.	18,741 €



Flexo extraíble para fregadero en latón reforzado

· 1,25 mts de longitud · Tuerca latón cónica H 1/2" G. · Temperatura máx. de trabajo 60° C · Presión máx. de trabajo 12 bar · Tubo en EPDM · Contrapeso de plomo incorporado

Ref.	Rosca	Embalaje	Uds.	Precio u.
6903	Rosca M 15/100	Skin	4 u.	19,867 €
6909	Rosca M 3/8" G.	Skin	4 u.	21,852 €



Contrapeso de plomo

· Para flexos extraíbles de cocina

Ref.	Embalaje	Uds.	Precio u.
69031	Bolsa	1 u.	5,250 €



Conjuntos para WC

Una forma higiénica y elegante de reemplazar el sistema clásico para la limpieza del WC, además de ser un sustituto perfecto del bidet.



Presentado en caja



Con el mango en el soporte, el suministro de agua se mantiene cerrado. Al descolgar el mango, se activa.

Kit WC Ydra Premium

· Compuesto por soporte con sistema de cierre de agua automático en latón cromado, mango de wc con cierre en latón (ref. 2420) y flexo de ducha en plástico plata metalizado 1 mts. (ref. 9016)

Ref.	Embalaje	Uds.	Precio u.
2450	Caja	1 u.	66,500 €



Kit WC Ydra básico

· Compuesto por soporte ABS cromado fijo (ref. 2334), mango de wc con cierre en ABS cromado (ref. 2420) y flexo de ducha en plástico plata metalizado (ref. 9016)

Ref.	Embalaje	Uds.	Precio u.
2410	Caja	1 u.	35,500 €



Flexo de ducha en plástico plata metalizado

· 1 mts. de longitud y Ø 15 mm. · Tuercas en latón H 1/2" G. cónicas lisas bajas · Higiénico y de fácil limpieza · Temperatura máx. de trabajo 90°C · Presión máx. de trabajo 20 bar

Ref.	Embalaje	Uds.	Precio u.
9016	Skin	1 u.	15,950 €



Mango para WC con cierre

· Fabricado en ABS cromado · Cierre incorporado · Rosca M 1/2" G.

Ref.	Embalaje	Uds.	Precio u.
2420	Skin	1 u.	11,750 €



Soporte

· Fabricado en ABS cromado · Incluye tacos y tornillos

Ref.	Embalaje	Uds.	Precio u.
2334	Skin	6 u.	2,726 €



Ydra básico x 5

PVP normal: ~~35,500-€~~
PVP en expositor: 34,500 €

Ducha lo x 10

PVP normal: ~~18,500-€~~
PVP en expositor: 16,000 €

Expositor Ydra básico + ducha lo

· Compuesto por 5 uds. de Kit básico Ydra (ref. 2410) y 10 uds. de mango de ducha lo (ref. 9825)

Ref.	Embalaje	Uds.	Precio u.
100125	Caja	1 u.	332,500 €



Ydra Premium x 5

PVP normal: ~~66,500-€~~
PVP en expositor: 63,500 €

Ducha lo x 10

PVP normal: ~~18,500-€~~
PVP en expositor: 16,000 €

Expositor Ydra Premium + ducha lo

· Compuesto por 5 uds. de Kit Premium Ydra (ref. 2450) y 10 uds. de mango de ducha lo (ref. 9825)

Ref.	Embalaje	Uds.	Precio u.
100150	Caja	1 u.	475,500 €



Ydra básico x 5

PVP normal: ~~35,500-€~~
PVP en expositor: 34,500 €

Ducha Sun x 5

PVP normal: ~~19,900-€~~
PVP en expositor: 17,670 €

Expositor Ydra básico + ducha Sun

· Compuesto por 5 uds. de Kit básico Ydra (ref. 2410) y 5 uds. de mango de ducha Sun (ref. 9850)

Ref.	Embalaje	Uds.	Precio u.
100175	Caja	1 u.	260,850 €



Ydra Premium x 5

PVP normal: ~~66,500-€~~
PVP en expositor: 63,500 €

Ducha Sun x 5

PVP normal: ~~19,900-€~~
PVP en expositor: 17,670 €

Expositor Ydra Premium + ducha Sun

· Compuesto por 5 uds. de Kit Premium Ydra (ref. 2450) y 5 uds. de mango de ducha Sun (ref. 9850)

Ref.	Embalaje	Uds.	Precio u.
100200	Caja	1 u.	405,850 €



Ydra básico x 5

PVP normal: ~~35,500-€~~
PVP en expositor: 34,500 €

Ducha Colors x 5

PVP normal: ~~39,905-€~~
PVP en expositor: 38,500 €



Ydra Premium x 5

PVP normal: ~~66,500-€~~
PVP en expositor: 63,500 €

Ducha Colors x 5

PVP normal: ~~39,905-€~~
PVP en expositor: 38,500 €

Expositor Ydra básico + ducha Colors

· Compuesto por 5 uds. de Kit básico Ydra (ref. 2410) y 5 uds. de mango de ducha Colors (ref. 9925)

Ref.	Embalaje	Uds.	Precio u.
100225	Caja	1 u.	365,000 €

Expositor Ydra Premium + ducha Colors

· Compuesto por 5 uds. de Kit básico Premium (ref. 2450) y 5 uds. de mango de ducha Colors (ref. 9925)

Ref.	Embalaje	Uds.	Precio u.
100250	Caja	1 u.	510,000 €



Ydra básico x 7

PVP normal: ~~35,500-€~~
PVP en expositor: 34,500 €



Ydra Premium x 7

PVP normal: ~~66,500-€~~
PVP en expositor: 63,500 €

Expositor Ydra básico

· Compuesto por 7 uds. de Kit básico Ydra (ref. 2410)

Ref.	Embalaje	Uds.	Precio u.
100275	Caja	1 u.	241,500 €

Expositor Ydra Premium

· Compuesto por 7 uds. de Kit Premium Ydra (ref. 2450)

Ref.	Embalaje	Uds.	Precio u.
100300	Caja	1 u.	444,500 €



4

4



Tubo de entrada para lavadora

- Interior en malla de poliéster recubierto en goma.
- Casquillos metálicos prensados.
- Boquillas fabricadas en nylon.
- Presión de trabajo: 15 bar.
- Presión máxima: 45 bar.
- Temperatura de trabajo: -15°C a + 50°C
- Goma marcada con fecha de fabricación, presión de trabajo y presión máxima.



Boquillas con
asientos planos

Medidas personalizables por encargo



Tubo de entrada con tuercas latón Skin EAN 13

Ref.	Medidas	Embalaje	Uds.	Precio u.
35191	1 mt.	Skin	30 u.	4,503 €
25111	1,5 mts.	Skin	15 u.	5,245 €
25121	2 mts.	Skin	15 u.	6,166 €
38151	2,5 mts.	Skin	12 u.	7,044 €
82871	3 mts.	Skin	10 u.	8,234 €

Tubo de entrada con tuercas latón Granel

Ref.	Medidas	Embalaje	Uds.	Precio u.
3519	1 mt.	Caja	30 u.	3,712 €
2511	1,5 mts.	Caja	20 u.	4,532 €
2512	2 mts.	Caja	15 u.	5,387 €
3815	2,5 mts.	Caja	12 u.	6,201 €
8287	3 mts.	Caja	10 u.	7,164 €



Tubo de entrada con tuercas nylon Skin EAN 13

Ref.	Medidas	Embalaje	Uds.	Precio u.
36251	1,5 mts.	Skin	15 u.	4,139 €
45341	2 mts.	Skin	15 u.	4,812 €
45351	2,5 mts.	Skin	12 u.	5,557 €
45361	3 mts.	Skin	10 u.	6,852 €

Tubo de entrada con tuercas nylon Granel

Ref.	Medidas	Embalaje	Uds.	Precio u.
3625	1,5 mts.	Caja	20 u.	3,339 €
4534	2 mts.	Caja	15 u.	4,012 €
4535	2,5 mts.	Caja	12 u.	4,755 €
4536	3 mts.	Caja	10 u.	6,104 €



Tubo de salida de lavadora en goma

· Fabricado en polipropileno · Temperatura de trabajo de -15° C a 120° C · Boquillas: Ø 19 mm x Ø 22 mm · Extensible de 60 a 200 cm

Ref.	Embalaje	Uds.	Precio u.
4660	Skin	15 u.	4,886 €



Boquilla enlace para tubo lavadora entrada

Ref.	Embalaje	Uds.	Precio u.
2575	Skin	15 u.	1,509 €



Duplicador con tuerca giratoria

Ref.	Embalaje	Uds.	Precio u.
2550	Skin	15 u.	3,055 €

Manguitos extensibles para WC 3097 / 3197

- Fabricados en polipropileno copolímero que garantiza que ningún sedimento se adhiera a la pared interna del tubo.
- Resistentes a grasas, agentes químicos y detergentes.
- Soportan ambientes con temperaturas críticas: -10° C a 60° C
- Montaje sin necesidad de adhesivos ni sellantes.



Fácil instalación tanto en suelo como en pared



Embalaje personalizable

NUEVO DISEÑO



Extensible de 220 mm a 510 mm



Fabricado en una sola pieza



Juntas termoplásticas soldadas al cuerpo

Manguito extensible para WC 3097

· Diámetros de desagüe: 90, 100, 110 y 120 mm. · Diámetros de wc: 80 y 120 mm.

Ref.	Embalaje	Uds.	Precio u.
3097	Bolsa ind.	6 u.	17,401 €
30971	Skin	6 u.	18,092 €



Extensible de 230 mm a 530 mm

Junta NBR 90°



EXTENSIBLE

NUEVO DISEÑO

Anillos internos en acero AISI 304

Manguito extensible para WC 3197

· Diámetros de desagüe: 90, 100, 110 y 120 mm. · Diámetros de wc: 80 y 120 mm.

Ref.	Embalaje	Uds.	Precio u.
3197	Bolsa ind.	6 u.	17,401 €
31971	Skin	6 u.	18,092 €



Manguito elástico recto para WC

· Parte interna completamente lisa · Ø 110 mm

Ref.	Embalaje	Uds.	Precio u.
3497	Bolsa ind.	12 u.	3,198 €
34971	Skin	12 u.	3,798 €



Manguito elástico excéntrico para WC

· Parte interna completamente lisa · Ø 110 mm

Ref.	Embalaje	Uds.	Precio u.
3597	Bolsa ind.	12 u.	3,198 €
35971	Skin	12 u.	3,798 €



Manguito acodado para WC

· Indicado para inodoros con salida dual · Diámetros de desagüe: 90, 100, 110 y 120 mm.

Ref.	Embalaje	Uds.	Precio u.
3697	Bolsa ind.	8 u.	8,815 €



Manguito acodado extensible para WC

· Diámetros de desagüe: 90, 100, 110 y 120 mm. · Diámetros de wc: 80 y 120 mm. · Junta NBR 90°

Ref.	Embalaje	Uds.	Precio u.
3797	Bolsa ind.	8 u.	18,270 €



5





Conjunto completo para peluquería

· Monomando con cierre del cartucho en latón y maneta en latón
 · Florón pasaflexo en latón de 48 x 17 mm · Mango de ducha fabricado en una sola pieza en ABS con rosca H 15/100 · Flexo de plástico especial liso de 1,20 m con tuerca M 15/100

Ref.	Embalaje	Uds.	Precio u.
8775	Caja	1 u.	99,950 €



Flexo HH 3/8" G.

· 1,3 mts de longitud · Completamente liso · Temperatura máxima de trabajo: 90° C · Tuercas H 3/8" G.

Ref.	Embalaje	Uds.	Precio u.
1244	Bolsa	1 u.	11,750 €
12441	Skin	1 u.	12,350 €



Flexo M 15/100 x H 3/8" G.

· Longitud de 1,3 mts · Completamente liso · Temperatura máxima de trabajo de 90° C · Tuerca M 15/100 y tuerca H 3/8" G.

Ref.	Embalaje	Uds.	Precio u.
8870	Bolsa	1 u.	7,950 €
88701	Skin	1 u.	8,550 €



1 - 65 x 15 mm



2 - 48 x 17 mm

Florón pasa flexo

· Fabricado en latón cromado/acero inoxidable · Incluye juntas

Ref.	Producto	Embalaje	Uds.	Precio u.
1234	1 - Válido para ref. 8700	Caja	1 u.	12,877 €
1235	2 - Válido para ref. 1224	Caja	1 u.	12,877 €



Mango de ducha peluquería M 3/8" G.

- Fabricado en una sola pieza en ABS · Rosca M 3/8" G.
- Espumante M 24/100 incorporado · Codo en latón cromado

Ref.	Embalaje	Uds.	Precio u.
1224	Bolsa	1 u.	16,240 €
12241	Skin	1 u.	16,840 €



Mango de ducha peluquería H 15/100

- Fabricado en una sola pieza en ABS · Rosca H 15/100.
- Espumante M-24/100 incorporado · Codo en latón cromado

Ref.	Embalaje	Uds.	Precio u.
8700	Bolsa	1 u.	18,085 €
87001	Skin	1 u.	18,685 €

5



Monomando peluquería

- Fabricado en latón cromado · Cierre cartucho en latón

Ref.	Embalaje	Uds.	Precio u.
1214	Caja	1 u.	71,590 €



Cartucho recambio para monomando peluquería

- Fabricado en ABS · Válido para refs. 8775 y 1214

Ref.	Embalaje	Uds.	Precio u.
1215	Caja	1 u.	27,166 €





6

Griferías industriales para uso profesional

El diseño de los equipos industriales Duchaflex® permite sustituir o añadir componentes rápidamente, obteniendo un total de 33 combinaciones que se adaptan a cualquier cocina profesional.

Muelle

- Fabricado en acero inoxidable.

Flexo

- Fabricado en acero inoxidable.
- Gran caudal de agua.
- Plástico exterior para una limpieza rápida.
- Superficie lisa e higiénica.

Ducha Nigra

- Diseñada para un uso intensivo.
- Rociador anticalcáreo.
- Regulador de caudal.
- Salida del agua a gran presión.

Soportes

- Fabricados en poliamida y fibra de vidrio: máxima resistencia.

Tubo

- Fabricado en latón barra para evitar roturas.

Grifo de llenado

- Montura cerámica con apertura/cierre de 1/4 de vuelta.

Monomando

- Cierre del cartucho en latón que elimina cualquier posibilidad de fuga de agua.



Nigra es una ducha prelavado concebida para su uso intensivo como instrumento de trabajo diario. Su diseño moderno y esencial destaca por la ergonomía, funcionalidad y resistencia. Además, la posibilidad de mantenimiento, le asegura una durabilidad excepcional.



- 1 Rosca 1/2" G. UNI ISO 228
- 2 Anilla de bloqueo de caudal en acero inoxidable.
- 3 Maneta ergonómica fabricada en tecnopolímero con apertura progresiva del agua.
- 4 Empuñadura fabricada en tecnopolímero.
- 5 Pistón en acero inoxidable AISI 304.
- 6 Regulador de caudal.
- 7 Cuerpo en latón cromado UNI EN 12164 H.
- 8 Aro fabricado en goma suave para absorber golpes.

Ducha prelavado Nigra

· Caudal máximo a 4 bar: 16 lit/min

Ref.	Embalaje	Uds.	Precio u.
3930	Caja	1 u.	96,500 €



Rociador recambio

· Fabricado en poliamida

Ref.	Embalaje	Uds.	Precio u.
3984	Caja	1 u.	6,750 €



Aro recambio

· Fabricado en goma suave

Ref.	Embalaje	Uds.	Precio u.
3985	Caja	1 u.	7,950 €



Rociador y aro protector desmontables para limpieza o sustitución.



Tuerca giratoria

Tuerca giratoria

Fabricado en acero inoxidable AISI 304 y con un recubrimiento en polipropileno, el flexo para grifería industrial está preparado para los trabajos más exigentes.

El acabado liso del tubo facilita su limpieza y dificulta la adherencia de suciedad.

Las tuercas giratorias en latón cromado evitan las torceduras y facilitan el trabajo.

Flexo grifería industrial

· 1,2 mts. de longitud · HH 1/2" UNI ISO 228

· Presión máx. de trabajo 10 bar · Temperatura de trabajo: 5° a 70° C · Diseñado para uso intensivo

Ref.	Embalaje	Uds.	Precio u.
6339	Skin	1 u.	48,710 €



Junta recambio 1/2" para flexo

· 18 x 10 x 5 mm · Fabricada en EPDM 70°

Ref.	Embalaje	Uds.	Precio u.
3654	Caja	1 u.	0,245 €



Equipo monomando repisa

· Cuerpo monomando fabricado en latón cromado con cierre de cartucho en latón · Grifo de llenado 1/4 de vuelta · Caño de 350 mm con aireador

Ref.	Maneta	Embalaje	Uds.	Precio u.
8310	Larga Medical	Caja	1 u.	430,500 €
8330	Recta estándar	Caja	1 u.	396,250 €



Equipo monomando repisa

· Cuerpo monomando fabricado en latón cromado con cierre de cartucho en latón · Grifo de llenado 1/4 de vuelta · Caño de 300 mm con aireador

Ref.	Maneta	Embalaje	Uds.	Precio u.
8315	Larga Medical	Caja	1 u.	398,500 €
8313	Recta estándar	Caja	1 u.	364,150 €



Equipo monomando repisa

· Cuerpo monomando fabricado en latón cromado con cierre de cartucho en latón

Ref.	Maneta	Embalaje	Uds.	Precio u.
6435	Larga Medical	Caja	1 u.	319,500 €
6431	Recta estándar	Caja	1 u.	285,250 €

Ref. 8310

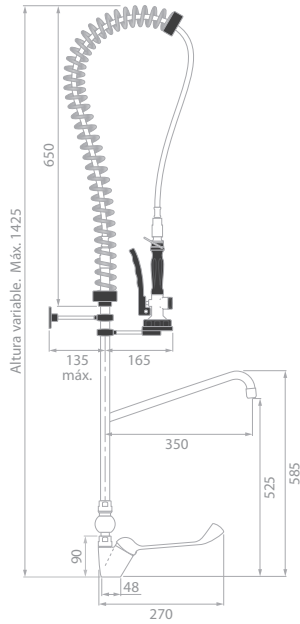

Ref. 8315

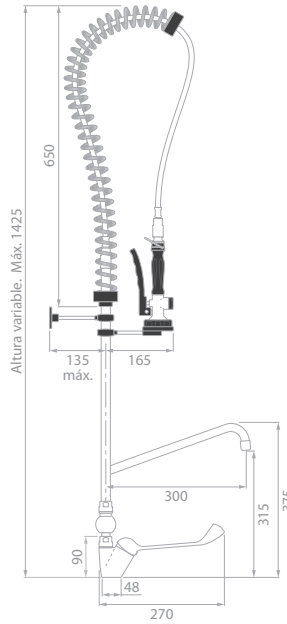

Ref. 6435

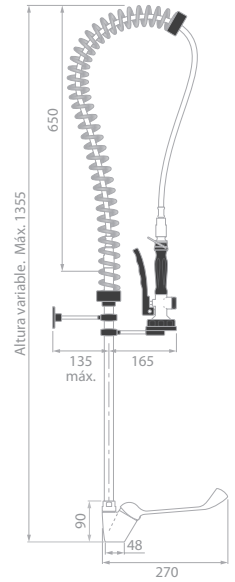

Ref. 8330

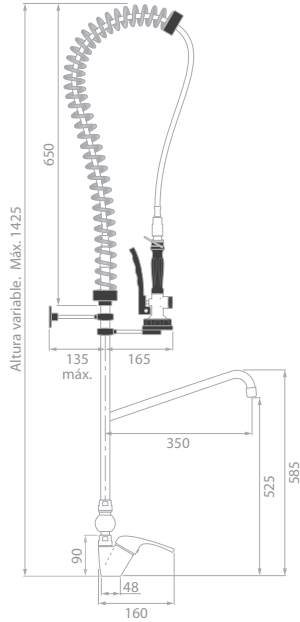

Ref. 8313

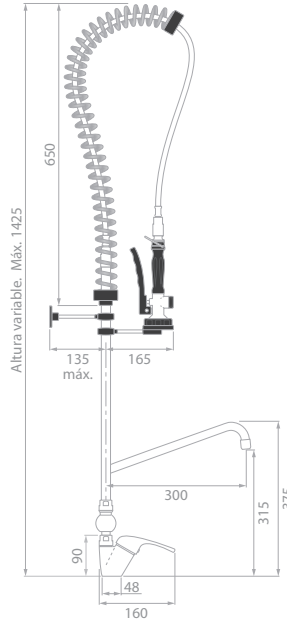

Ref. 6431

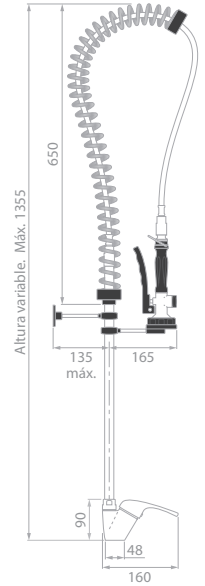

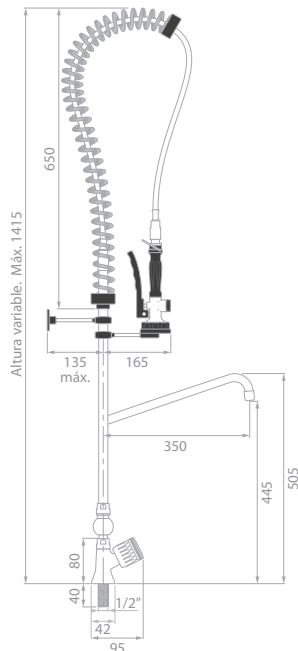

Equipo un agua repisa

· Cuerpo un agua fabricado en latón cromado · Volante grafilado en latón cromado · Caño de 350 mm con aireador · Grifo de llenado 1/4 de vuelta

Ref.	Montura	Embalaje	Uds.	Precio u.
6555	Cerámica 1/4 de vuelta	Caja	1 u.	340,750 €
6530	Estándar	Caja	1 u.	332,250 €

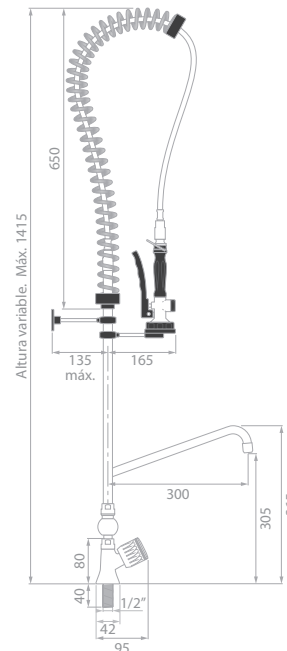

Equipo un agua repisa

· Cuerpo un agua fabricado en latón cromado · Volante grafilado en latón cromado · Caño de 300 mm con aireador · Grifo de llenado 1/4 de vuelta

Ref.	Montura	Embalaje	Uds.	Precio u.
6545	Cerámica 1/4 de vuelta	Caja	1 u.	306,750 €
6535	Estándar	Caja	1 u.	297,750 €

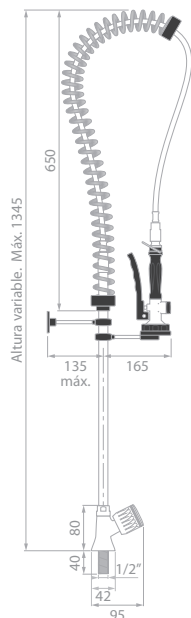

Equipo un agua repisa

· Cuerpo un agua fabricado en latón cromado · Volante grafilado en latón cromado

Ref.	Montura	Embalaje	Uds.	Precio u.
6540	Cerámica 1/4 de vuelta	Caja	1 u.	247,950 €
6525	Estándar	Caja	1 u.	239,750 €

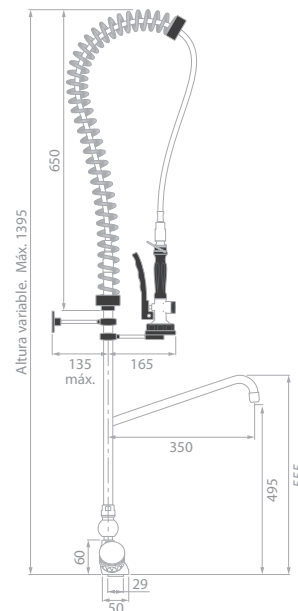

Equipo monobloc repisa

· Cuerpo monobloc fabricado en latón cromado · Volantes grafilados en latón cromado · Caño de 350 mm con aireador · Grifo de llenado 1/4 de vuelta

Ref.	Montura	Embalaje	Uds.	Precio u.
8390	Cerámica 1/4 de vuelta	Caja	1 u.	384,950 €
8392	Estándar	Caja	1 u.	369,750 €

6

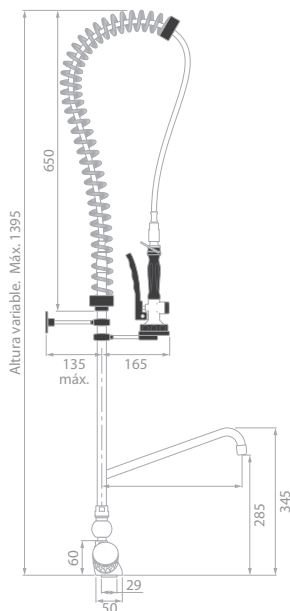

Equipo monobloc repisa

- Cuerpo monobloc fabricado en latón cromado · Volantes grafilados en latón cromado · Caño de 300 mm con aireador
- Grifo de llenado 1/4 de vuelta

Ref.	Montura	Embalaje	Uds.	Precio u.
8394	Cerámica 1/4 de vuelta	Caja	1 u.	347,500 €
8396	Estándar	Caja	1 u.	335,250 €

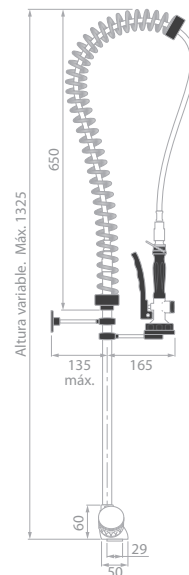

Equipo monobloc repisa

- Cuerpo monobloc fabricado en latón cromado · Volantes grafilados en latón cromado

Ref.	Montura	Embalaje	Uds.	Precio u.
8397	Cerámica 1/4 de vuelta	Caja	1 u.	289,500 €
8398	Estándar	Caja	1 u.	275,250 €

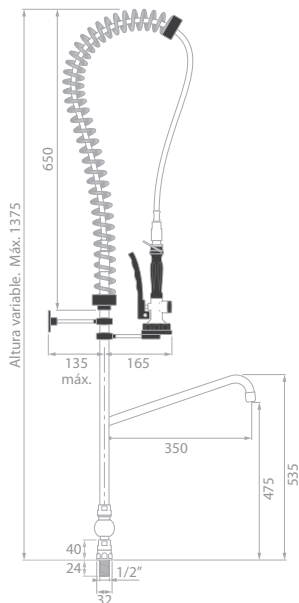

Equipo repisa sin grifo

· Caño de 350 mm con aireador · Grifo de llenado 1/4 de vuelta

Ref.	Embalaje	Uds.	Precio u.
5660	Caja	1 u.	308,250 €

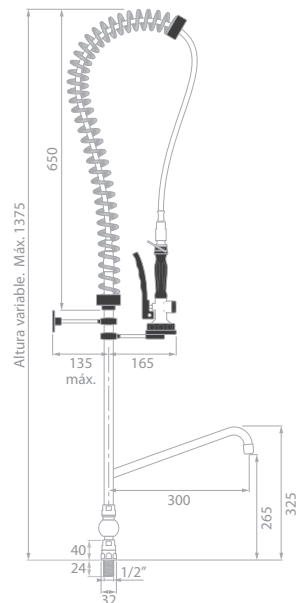

Equipo repisa sin grifo

· Caño de 300 mm con aireador · Grifo de llenado 1/4 de vuelta

Ref.	Embalaje	Uds.	Precio u.
6565	Caja	1 u.	276,500 €

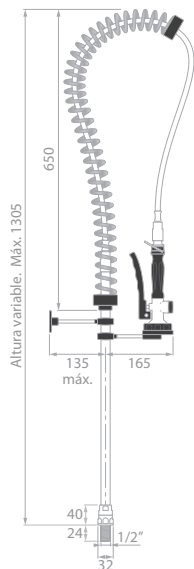

Equipo repisa sin grifo

Ref.	Embalaje	Uds.	Precio u.
6531	Caja	1 u.	198,250 €

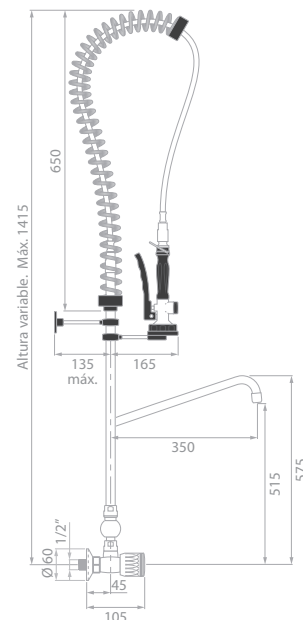

Equipo monobloc mural

· Cuerpo monobloc en latón cromado · Volantes grafilados en latón cromado · Grifo de llenado 1/4 de vuelta · Caño de 350 mm con aireador

Ref.	Montura	Embalaje	Uds.	Precio u.
8345	Cerámica 1/4 de vuelta	Caja	1 u.	449,750 €
8325	Estándar	Caja	1 u.	415,250 €

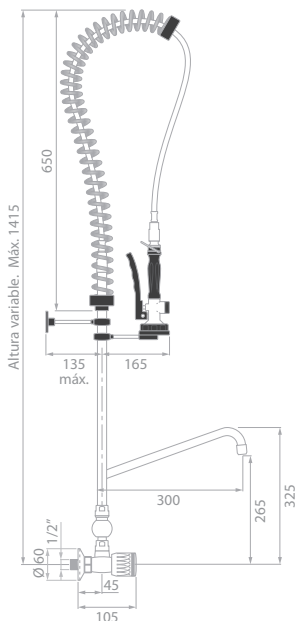

Equipo monobloc mural

· Cuerpo monobloc en latón cromado · Volantes grafilados en latón cromado · Grifo de llenado 1/4 de vuelta · Caño de 300 mm con aireador

Ref.	Montura	Embalaje	Uds.	Precio u.
8360	Cerámica 1/4 de vuelta	Caja	1 u.	399,750 €
8340	Estándar	Caja	1 u.	385,750 €

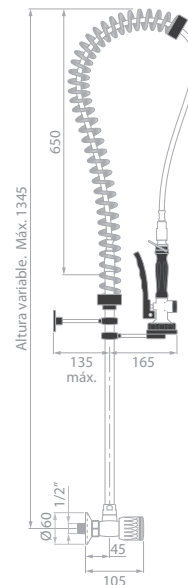

Equipo monobloc mural

· Cuerpo monobloc en latón cromado · Volantes grafilados en latón cromado

Ref.	Montura	Embalaje	Uds.	Precio u.
8385	Cerámica 1/4 de vuelta	Caja	1 u.	299,750 €
8380	Estándar	Caja	1 u.	290,500 €



Equipo monomando mural

· Cuerpo monomando fabricado en latón cromado con cierre de cartucho en latón · Grifo de llenado 1/4 de vuelta · Caño de 350 mm con espumante

Ref.	Maneta	Embalaje	Uds.	Precio u.
8314	Larga Medical	Caja	1 u.	484,250 €
8312	Recta estándar	Caja	1 u.	449,500 €



Equipo monomando mural

· Cuerpo monomando fabricado en latón cromado con cierre de cartucho en latón · Grifo de llenado 1/4 de vuelta · Caño de 300 mm con espumante

Ref.	Maneta	Embalaje	Uds.	Precio u.
8305	Larga Medical	Caja	1 u.	449,500 €
8311	Recta estándar	Caja	1 u.	415,500 €



Equipo monomando mural

· Cuerpo monomando fabricado en latón cromado con cierre de cartucho en latón

Ref.	Maneta	Embalaje	Uds.	Precio u.
6805	Larga Medical	Caja	1 u.	354,250 €
6809	Recta estándar	Caja	1 u.	319,750 €

Ref. 8314

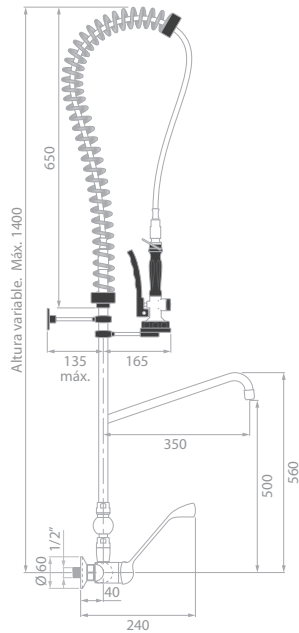

Ref. 8305

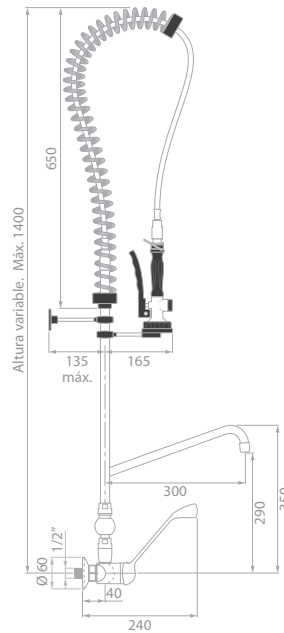

Ref. 6805

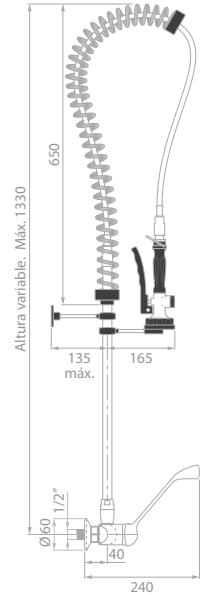

Ref. 8312

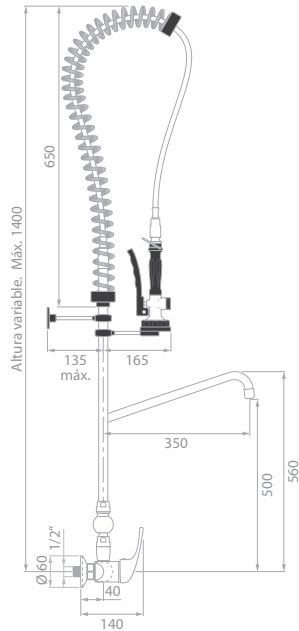

Ref. 8311

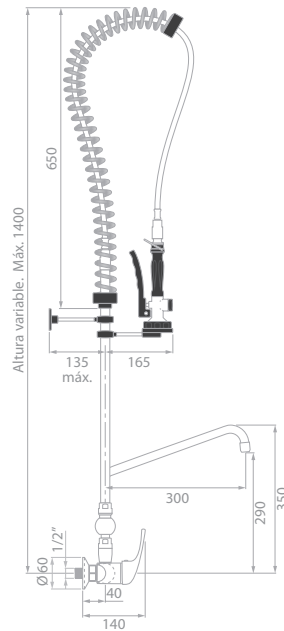

Ref. 6809

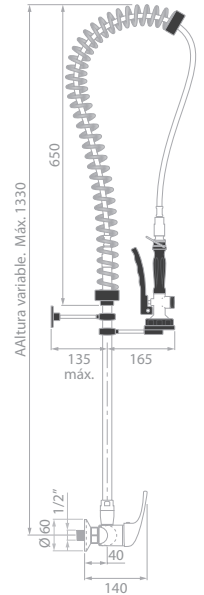

6



Modelo 6700 caño alto 350 mm

· Cuerpo monomando fabricado en latón cromado con cierre de cartucho en latón · Caño de 350 mm con aireador · Maneta recta estándar · Caudal máximo a 4 bar 18 lit/min

Ref.	Embalaje	Uds.	Precio u.
6700	Bolsa ind.	1 u.	135,500 €



Modelo 6710 caño alto 350 mm

· Cuerpo monomando fabricado en latón cromado con cierre de cartucho en latón · Caño de 350 mm con aireador · Maneta larga Medical · Caudal máximo a 4 bar 18 lit/min

Ref.	Embalaje	Uds.	Precio u.
6710	Bolsa ind.	1 u.	167,500 €



Modelo 6715 caño 300 mm

· Cuerpo monomando fabricado en latón cromado con cierre de cartucho en latón · Caño de 300 mm con aireador · Maneta larga Medical · Caudal máximo a 4 bar 18 lit/min

Ref.	Embalaje	Uds.	Precio u.
6715	Bolsa ind.	1 u.	142,500 €



Modelo 6705 caño 300 mm

· Cuerpo monomando fabricado en latón cromado con cierre de cartucho en latón · Caño de 300 mm con aireador · Maneta recta estándar · Caudal máximo a 4 bar 18 lit/min

Ref.	Embalaje	Uds.	Precio u.
6705	Bolsa ind.	1 u.	110,500 €

NUEVO

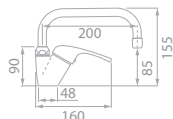

Ideal instalaciones bajo barra

Modelo 6708 caño bajo 200 mm

· Cuerpo monomando fabricado en latón cromado con cierre de cartucho en latón · Caño de 200 mm con aireador · Maneta recta estándar · Caudal máximo a 4 bar 18 lit/min

Ref.	Embalaje	Uds.	Precio u.
6708	Caja	1 u.	88,750 €

NUEVO

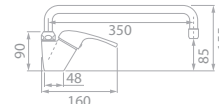

Ideal instalaciones bajo barra

Modelo 6835 caño bajo 350 mm

· Cuerpo monomando fabricado en latón cromado con cierre de cartucho en latón · Caño de 350 mm con aireador · Maneta recta estándar · Caudal máximo a 4 bar 18 lit/min

Ref.	Embalaje	Uds.	Precio u.
6835	Caja	1 u.	125,500 €

6

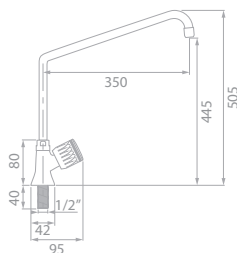

Modelo 6742 caño alto 350 mm

· Cuerpo un agua fabricado en latón cromado · Volante grafilado en latón cromado · Caño de 350 mm con aireador · Caudal máximo a 4 bar 25 lit/min

Ref.	Montura	Embalaje	Uds.	Precio u.
6742	Cerámica 1/4 de vuelta	Caja	1 u.	76,250 €
6740	Estándar	Caja	1 u.	68,250 €

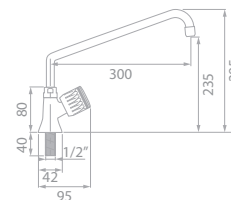

Modelo 6747 caño alto 300 mm

· Cuerpo un agua fabricado en latón cromado · Volante grafilado en latón cromado · Caño de 300 mm con aireador · Caudal máximo a 4 bar 25 lit/min

Ref.	Montura	Embalaje	Uds.	Precio u.
6747	Cerámica 1/4 de vuelta	Caja	1 u.	59,250 €
6745	Estándar	Caja	1 u.	51,250 €

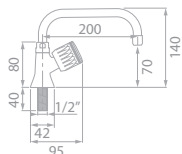

NUEVO

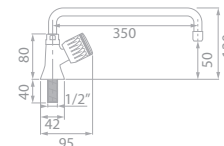

Ideal instalaciones bajo barra

Modelo 6757 caño bajo 200 mm

· Cuerpo un agua fabricado en latón cromado · Volante grafilado en latón cromado · Caño de 200 mm con aireador · Caudal máximo a 4 bar 25 lit/min

Ref.	Montura	Embalaje	Uds.	Precio u.
6757	Cerámica 1/4 de vuelta	Caja	1 u.	37,250 €
6755	Estándar	Caja	1 u.	29,250 €

Ideal instalaciones bajo barra

Modelo 6795 caño bajo 350 mm

· Cuerpo un agua fabricado en latón cromado · Volante grafilado en latón cromado · Caño de 200 mm con aireador · Caudal máximo a 4 bar 25 lit/min

Ref.	Montura	Embalaje	Uds.	Precio u.
6795	Cerámica 1/4 de vuelta	Caja	1 u.	59,900 €
6797	Estándar	Caja	1 u.	51,900 €

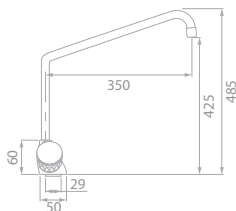

Modelo 6762 caño alto 350 mm

· Cuerpo monobloc fabricado en latón cromado · Volantes grafilados en latón cromado · Caño de 350 mm con aireador · Caudal máximo a 4 bar 21 lit/min

Ref.	Montura	Embalaje	Uds.	Precio u.
6762	Cerámica 1/4 de vuelta	Caja	1 u.	90,500 €
6763	Estándar	Caja	1 u.	82,500 €

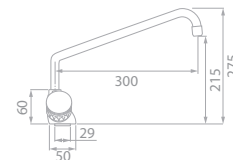

Modelo 6767 caño 300 mm

· Cuerpo monobloc fabricado en latón cromado · Volantes grafilados en latón cromado · Caño de 300 mm con aireador · Caudal máximo a 4 bar 21 lit/min

Ref.	Montura	Embalaje	Uds.	Precio u.
6767	Cerámica 1/4 de vuelta	Caja	1 u.	71,500 €
6765	Estándar	Caja	1 u.	63,500 €

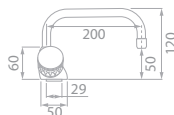

Ideal instalaciones bajo barra

Modelo 6772 caño bajo 200 mm

- Cuerpo monobloc fabricado en latón cromado · Volantes grafilados en latón cromado · Caño de 200 mm con aireador
- Caudal máximo a 4 bar 21 lit/min

Ref.	Montura	Embalaje	Uds.	Precio u.
6772	Cerámica 1/4 de vuelta	Caja	1 u.	49,500 €
6760	Estándar	Caja	1 u.	41,500 €

NUEVO

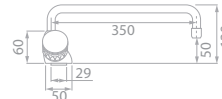

Ideal instalaciones bajo barra

Modelo 6200 caño bajo 350 mm

- Cuerpo monobloc fabricado en latón cromado · Volantes grafilados en latón cromado · Caño de 350 mm con aireador
- Caudal máximo a 4 bar 21 lit/min

Ref.	Montura	Embalaje	Uds.	Precio u.
6200	Cerámica 1/4 de vuelta	Caja	1 u.	72,150 €
6205	Estándar	Caja	1 u.	64,150 €

6

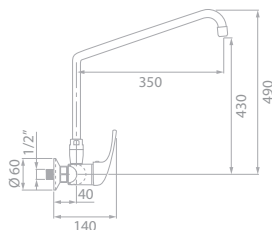

Modelo 6720 caño alto 350 mm

- Cuerpo monomando fabricado en latón cromado con cierre de cartucho en latón · Maneta recta estándar · Caño de 350 mm con aireador · Caudal máximo a 4 bar 25 lit/min

Ref.	Embalaje	Uds.	Precio u.
6720	Caja	1 u.	195,850 €

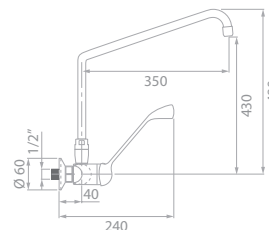

Modelo 6730 caño alto 350 mm

- Cuerpo monomando fabricado en latón cromado con cierre de cartucho en latón · Maneta larga Medical · Caño de 350 mm con aireador · Caudal máximo a 4 bar 25 lit/min

Ref.	Embalaje	Uds.	Precio u.
6730	Caja	1 u.	218,750 €

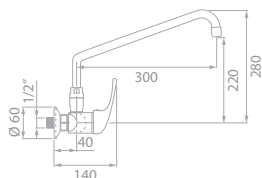

Modelo 6725 caño 300 mm

· Cuerpo monomando fabricado en latón cromado con cierre de cartucho en latón · Maneta recta estándar · Caño de 300 mm con aireador · Caudal máximo a 4 bar 25 lit/min

Ref.	Embalaje	Uds.	Precio u.
6725	Caja	1 u.	171,250 €

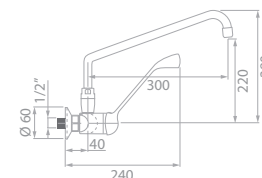

Modelo 6735 caño 300 mm

· Cuerpo monomando fabricado en latón cromado con cierre de cartucho en latón · Maneta larga Medical · Caño de 300 mm con aireador · Caudal máximo a 4 bar 25 lit/min

Ref.	Embalaje	Uds.	Precio u.
6735	Caja	1 u.	193,650 €

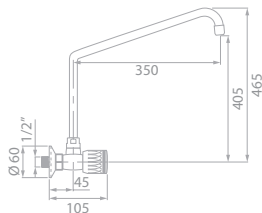

Modelo 6782 caño alto 350 mm

· Cuerpo monobloc en latón cromado · Volantes grafilados en latón cromado · Caño de 350 mm con aireador · Caudal máximo a 4 bar 26 lit/min

Ref.	Montura	Embalaje	Uds.	Precio u.
6782	Cerámica 1/4 de vuelta	Caja	1 u.	98,500 €
6780	Estándar	Caja	1 u.	90,500 €

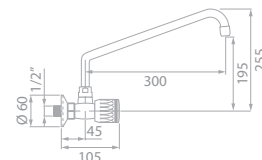

Modelo 6787 caño 300 mm

· Cuerpo monobloc en latón cromado · Volantes grafilados en latón cromado · Caño de 300 mm con aireador · Caudal máximo a 4 bar 26 lit/min

Ref.	Montura	Embalaje	Uds.	Precio u.
6787	Cerámica 1/4 de vuelta	Caja	1 u.	79,500 €
6785	Estándar	Caja	1 u.	71,500 €

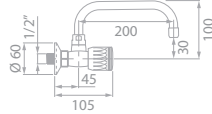

NUEVO

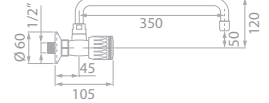

Ideal instalaciones bajo barra

Modelo 3596 caño bajo 200 mm

· Cuerpo monobloc en latón cromado · Volantes grafilados en latón cromado · Caño de 200 mm con aireador · Caudal máximo a 4 bar 26 lit/min

Ref.	Montura	Embalaje	Uds.	Precio u.
3596	Cerámica 1/4 de vuelta	Caja	1 u.	57,500 €
3594	Estándar	Caja	1 u.	49,500 €

Ideal instalaciones bajo barra

Modelo 6788 caño bajo 350 mm

· Cuerpo monobloc en latón cromado · Volantes grafilados en latón cromado · Caño de 350 mm con aireador · Caudal máximo a 4 bar 26 lit/min

Ref.	Montura	Embalaje	Uds.	Precio u.
6788	Cerámica 1/4 de vuelta	Caja	1 u.	97,750 €
6789	Estándar	Caja	1 u.	89,750 €





Cuerpo un agua

· Montura estándar cromada · Fabricado en latón cromado

Ref.	Embalaje	Uds.	Precio u.
6520	Caja	1 u.	22,500 €



Cuerpo monobloc repisa

· Monturas estándar · Fabricado en latón cromado

Ref.	Embalaje	Uds.	Precio u.
6515	Caja	1 u.	26,500 €



Cuerpo monobloc pared

· Monturas estándar · Fabricado en latón cromado

Ref.	Embalaje	Uds.	Precio u.
6886	Caja	1 u.	39,500 €



Cuerpo monomando repisa

· Cartucho con cierre en latón · Fabricado en latón cromado

Ref.	Embalaje	Uds.	Precio u.
8355	Caja	1 u.	71,750 €



Cuerpo monomando pared

· Cartucho con cierre en latón · Fabricado en latón cromado

Ref.	Embalaje	Uds.	Precio u.
8825	Caja	1 u.	125,500 €



Soporte fijación

· Fabricado en poliamida

Ref.	Embalaje	Uds.	Precio u.
6882	Caja	1 u.	16,750 €



Volante grafilado

· Fabricada en latón cromado

Ref.	Embalaje	Uds.	Precio u.
6855	Caja	1 u.	6,250 €



Maneta recta estándar

· Fabricada en latón cromado

Ref.	Embalaje	Uds.	Precio u.
6820	Caja	1 u.	26,500 €



Maneta larga Medical

· Fabricada en latón cromado

Ref.	Embalaje	Uds.	Precio u.
6819	Caja	1 u.	39,500 €



Montura 1/2" cerámica

· Válida para refs. 6520, 6515 y 6886

Ref.	Embalaje	Uds.	Precio u.
6870	Caja	1 u.	9,500 €



Montura 1/2" estándar

· Válida para refs. 6515 y 6886

Ref.	Embalaje	Uds.	Precio u.
6890	Caja	1 u.	4,800 €



Montura 1/2" cromada

· Válida para ref. 6520

Ref.	Embalaje	Uds.	Precio u.
6860	Caja	1 u.	4,900 €



Kit fijación inferior

· Válido para refs. 6515 y 8355

Ref.	Embalaje	Uds.	Precio u.
4250	Caja	1 u.	3,050 €



Kit fijación inferior

· Válido para refs. 6520 y 6882

Ref.	Embalaje	Uds.	Precio u.
6880	Caja	1 u.	8,750 €



Kit fijación inferior

· Válido para ref. 5520

Ref.	Embalaje	Uds.	Precio u.
6875	Caja	1 u.	3,250 €



Conexión H 1/2" x 60 cm

· Fabricada en acero inoxidable

Ref.	Embalaje	Uds.	Precio u.
4282	Bolsa	1 u.	3,980 €



Conexión H 3/8" x 30 cm

· Fabricada en acero inoxidable

Ref.	Embalaje	Uds.	Precio u.
41811	Skin	1 u.	2,980 €



Cartucho recambio

· Válido para ref. 8355

Ref.	Embalaje	Uds.	Precio u.
6931	Caja	1 u.	28,500 €



Cartucho recambio

· Válido para ref. 8825

Ref.	Embalaje	Uds.	Precio u.
6932	Caja	1 u.	33,750 €



Soporte inferior para muelle

· Fabricado en tecnopolímero

Ref.	Embalaje	Uds.	Precio u.
7065	Caja	1 u.	4,500 €



Conjunto de fijaciones

· Fabricado en tecnopolímero y acero inoxidable · Fijación de pared y soporte para ducha prelavado Nigra

Ref.	Embalaje	Uds.	Precio u.
7075	Caja	1 u.	21,750 €



Tornillo y tuerca M6

· Fabricados en acero inoxidable

Ref.	Producto	Embalaje	Uds.	Precio u.
7080	Tornillo	Bolsa	1 u.	0,420 €
7082	Tuerca	Bolsa	1 u.	0,420 €



Tubo con tuerca H 3/4" G.

· Fabricado en latón cromado

Ref.	Embalaje	Uds.	Precio u.
7050	Caja	2 u.	38,750 €



Tuerca H 3/4" G. para tubo

· Fabricada en latón cromado

Ref.	Embalaje	Uds.	Precio u.
7055	Caja	2 u.	0000 €



Muelle recambio

· Fabricado en acero inoxidable

Ref.	Embalaje	Uds.	Precio u.
6631	Bolsa	1 u.	36,570 €



Grifo de llenado

· Fabricado en latón cromado · Montura cerámica 1/4 de vuelta

Ref.	Embalaje	Uds.	Precio u.
7060	Caja	1 u.	92,500 €



Maneta para grifo de llenado

· Fabricado en latón cromado

Ref.	Embalaje	Uds.	Precio u.
7062	Caja	1 u.	11,750 €



Caño alto 350 mm

· Fabricado en latón cromado

Ref.	Embalaje	Uds.	Precio u.
6732	Caja	1 u.	39,750 €



Caño alto 200 mm

· Fabricado en latón cromado

Ref.	Embalaje	Uds.	Precio u.
6790	Caja	1 u.	28,390 €



Caño alto 300 mm

· Fabricado en latón cromado

Ref.	Embalaje	Uds.	Precio u.
6731	Caja	1 u.	28,390 €



Caño recto 350 mm

· Fabricado en latón cromado

Ref.	Embalaje	Uds.	Precio u.
8080	Caja	1 u.	28,390 €



Caño recto 200 mm

· Fabricado en latón cromado

Ref.	Embalaje	Uds.	Precio u.
8075	Caja	1 u.	9,450 €



Caño 150 mm

· Fabricado en latón cromado

Ref.	Embalaje	Uds.	Precio u.
8085	Caja	1 u.	9,470 €



Modelo 6940

· Fabricado totalmente en latón cromado · Caño de 250 mm con aireador · Caudal máximo a 4 bar de presión 24 lit/min

Ref.	Montura	Embalaje	Uds.	Precio u.
6940	Estándar	Caja	1 u.	225,000 €
6942	Cerámica 1/4 de vuelta	Caja	1 u.	235,000 €



Monturas recambio

· Fabricado totalmente en latón cromado · Caño de 250 mm con

Ref.	Producto	Embalaje	Uds.	Precio u.
6895	Estándar	Caja	1 u.	7,500 €
6870	Cerámica 1/4 de vuelta	Caja	1 u.	9,500 €



Caño recambio 250 mm

· Fabricado en latón cromado · Aireador incorporado

Ref.	Embalaje	Uds.	Precio u.
6955	Bolsa ind.	1 u.	23,750 €



Volante recambio

· Fabricado en latón cromado · Índice azul

Ref.	Embalaje	Uds.	Precio u.
6945	Bolsa ind.	1 u.	12,790 €



Kit fijación inferior recambio

· Rosca en latón · Junta · Arandela

Ref.	Embalaje	Uds.	Precio u.
6950	Bolsa ind.	1 u.	8,250 €



Modelo 6900

· Fabricado totalmente en latón cromado · Caño de 400 mm con espumante · Caudal máximo a 4 bar de presión 24 lit/min

Ref.	Embalaje	Uds.	Precio u.
6900	Caja	1 u.	294,000 €



Montura recambio

· Montura M22x100 · 3/4" G. tornillo M4

Ref.	Embalaje	Uds.	Precio u.
6925	Bolsa ind.	1 u.	8,750 €



Sujeción inferior recambio

· Rosca 2" G. · Fabricada en latón

Ref.	Embalaje	Uds.	Precio u.
6935	Bolsa ind.	1 u.	5,750 €



Caño recambio

· Fabricado en latón cromado · Aireador incorporado

Ref.	Embalaje	Uds.	Precio u.
6910	Caja	1 u.	56,570 €



Volante recambio

· Fabricado en latón cromado

Ref.	Índice	Embalaje	Uds.	Precio u.
6915	Azul	Bolsa ind.	1 u.	16,800 €
6920	Rojo	Bolsa ind.	1 u.	16,800 €



Conexión inoxidable

· H 1/2 " x 80 cm

Ref.	Embalaje	Uds.	Precio u.
6930	Bolsa ind.	1 u.	5,960 €



Grifo pedal con caño

- Pedal un agua (ref. 6831)
- Caño M 1/2" G. de 350 mm (ref. 6965)

Ref.	Embalaje	Uds.	Precio u.
6400	Caja	1 u.	145,000 €



Grifo pedal con caño

- Pedal mezclador (ref.6852)
- Caño M 1/2" G. de 350 mm (ref. 6965)

Ref.	Embalaje	Uds.	Precio u.
6415	Caja	1 u.	199,500 €



Grifo pedal con caño

- Pedal agua fria y caliente (ref. 6854)
- Caño M 1/2" G. de 350 mm (ref. 6965)

Ref.	Embalaje	Uds.	Precio u.
6430	Bolsa	1 u.	203,750 €



Grifo pedal con caño

- Pedal un agua (ref. 6831)
- Caño M 1/2" G. de 200 mm (ref. 6958)

Ref.	Embalaje	Uds.	Precio u.
6450	Caja	1 u.	129,250 €



Grifo pedal con caño

- Pedal mezclador (ref.6852)
- Caño M 1/2" G. de 200 mm (ref. 6958)

Ref.	Embalaje	Uds.	Precio u.
6470	Caja	1 u.	185,250 €



Grifo pedal con caño

- Pedal agua fria y caliente (ref. 6854)
- Caño M 1/2" G. de 200 mm (ref. 6958)

Ref.	Embalaje	Uds.	Precio u.
6460	Caja	1 u.	188,500 €



Grifo pedal con caño

- Pedal un agua (ref. 6831)
- Caño M 1/2" G. de 300 mm (ref. 6970)

Ref.	Embalaje	Uds.	Precio u.
6405	Caja	1 u.	129,250 €



Grifo pedal con caño

- Pedal mezclador (ref.6852)
- Caño M 1/2" G. de 300 mm (ref.6970)

Ref.	Embalaje	Uds.	Precio u.
6420	Caja	1 u.	185,250 €



Grifo pedal con caño

- Pedal agua fria y caliente (ref. 6854)
- Caño M 1/2" G. de 300 mm (ref.6970)

Ref.	Embalaje	Uds.	Precio u.
6440	Caja	1 u.	188,500 €

6



Grifo pedal con caño

- Pedal un agua (ref. 6831)
- Caño M 1/2" G. de 150 mm (ref. 6865)

Ref.	Embalaje	Uds.	Precio u.
6410	Caja	1 u.	113,750 €



Grifo pedal con caño

- Pedal mezclador (ref.6852)
- Caño M 1/2" G. de 150 mm (ref. 6865)

Ref.	Embalaje	Uds.	Precio u.
6425	Caja	1 u.	171,250 €



Grifo pedal con caño

- Pedal agua fria y caliente (ref. 6854)
- Caño M 1/2" G. de 150 mm (ref. 6865)

Ref.	Embalaje	Uds.	Precio u.
6445	Caja	1 u.	173,500 €



Filtro en acero inoxidable AISI 304

Grifo pedal un agua

· Un agua · Fabricado en latón UNE EN-1982 · Cartucho interior en latón · Caudal máx. a 4 bar de presión 18 lit/min

Ref.	Embalaje	Uds.	Precio u.
6831	Caja	1 u.	95,100 €



Filtro en acero inoxidable AISI 304

Grifo pedal mezclador

· Fabricado en latón UNE EN-1982 · Cartucho interior en latón · Caudal máx. a 4 bar de presión 18 lit/min

Ref.	Embalaje	Uds.	Precio u.
6852	Caja	1 u.	152,500 €



Filtro en acero inoxidable AISI 304

Grifo doble pedal

· Agua fría y caliente · Fabricado en latón UNE EN-1982 · Cartucho interior en latón · Caudal máx. a 4 bar de presión 18 lit/min

Ref.	Embalaje	Uds.	Precio u.
6854	Caja	1 u.	155,250 €



Cartucho recambio para pedal

· Fabricado en latón

Ref.	Embalaje	Uds.	Precio u.
6858	Caja	1 u.	62,400 €



Muelle para pedales

· Fabricado en acero inoxidable AISI 316

Ref.	Embalaje	Uds.	Precio u.
6859	Caja	1 u.	3,740 €



Soporte fijación para caño

· Fabricado en latón cromado

Ref.	Embalaje	Uds.	Precio u.
6960	Caja	1 u.	18,750 €



Caño 350 mm giratorio

· Fabricado en latón cromado · Rosca 1/2" · Aireador H 22/100 incorporado

Ref.	Producto	Embalaje	Uds.	Precio u.
6965	Con aireador normal	Caja	1 u.	57,500 €
6966	Con aireador ahorrador	Caja	1 u.	59,500 €

NUEVO



Caño 200 mm giratorio

· Fabricado en latón cromado · Rosca 1/2" · Aireador H 22/100 incorporado

Ref.	Producto	Embalaje	Uds.	Precio u.
6958	Con aireador normal	Caja	1 u.	38,250 €
6959	Con aireador ahorrador	Caja	1 u.	40,250 €

6



Caño 300 mm giratorio

· Fabricado en latón cromado · Rosca 1/2" · Aireador H 22/100 incorporado

Ref.	Producto	Embalaje	Uds.	Precio u.
6970	Con aireador normal	Caja	1 u.	38,250 €
6975	Con aireador ahorrador	Caja	1 u.	40,250 €



Caño 150 mm giratorio

· Fabricado en latón cromado · Rosca 1/2" · Aireador H 22/100 incorporado

Ref.	Producto	Embalaje	Uds.	Precio u.
6865	Con aireador normal	Caja	1 u.	24,500 €
6866	Con aireador ahorrador	Caja	1 u.	26,500 €





Botón de apertura del agua

Kit limpieza para horno

Compuesto por: ducha para horno (ref.2415), flexo 2 mts. (ref. 9024) y soporte ajustable (ref.2332)

Ref.	Embalaje	Uds.	Precio u.
2415	Caja	1 u.	42,500 €



Ducha para horno

· Salida de agua al alta presión · Fabricada en ABS de alta densidad · Resistente a altas temperaturas · Pistón interior fabricado en latón barra

Ref.	Embalaje	Uds.	Precio u.
2445	Skin	1 u.	26,500 €



Higiénico y de fácil limpieza

Medidas y colores personalizables



Flexo plástico reforzado 2 mts

· Trenzado interior de 24 hilos en poliéster TIT 1000: extraordinaria resistencia a altas temperaturas y presiones · Posibilidad de fabricar cualquier medida

Ref.	Embalaje	Uds.	Precio u.
9024	Skin	1 u.	16,750 €



Soporte

· Fabricado an ABS · Inclinación regulable · Incluye tacos y tornillos

Ref.	Embalaje	Uds.	Precio u.
2332	Skin	1 u.	4,250 €

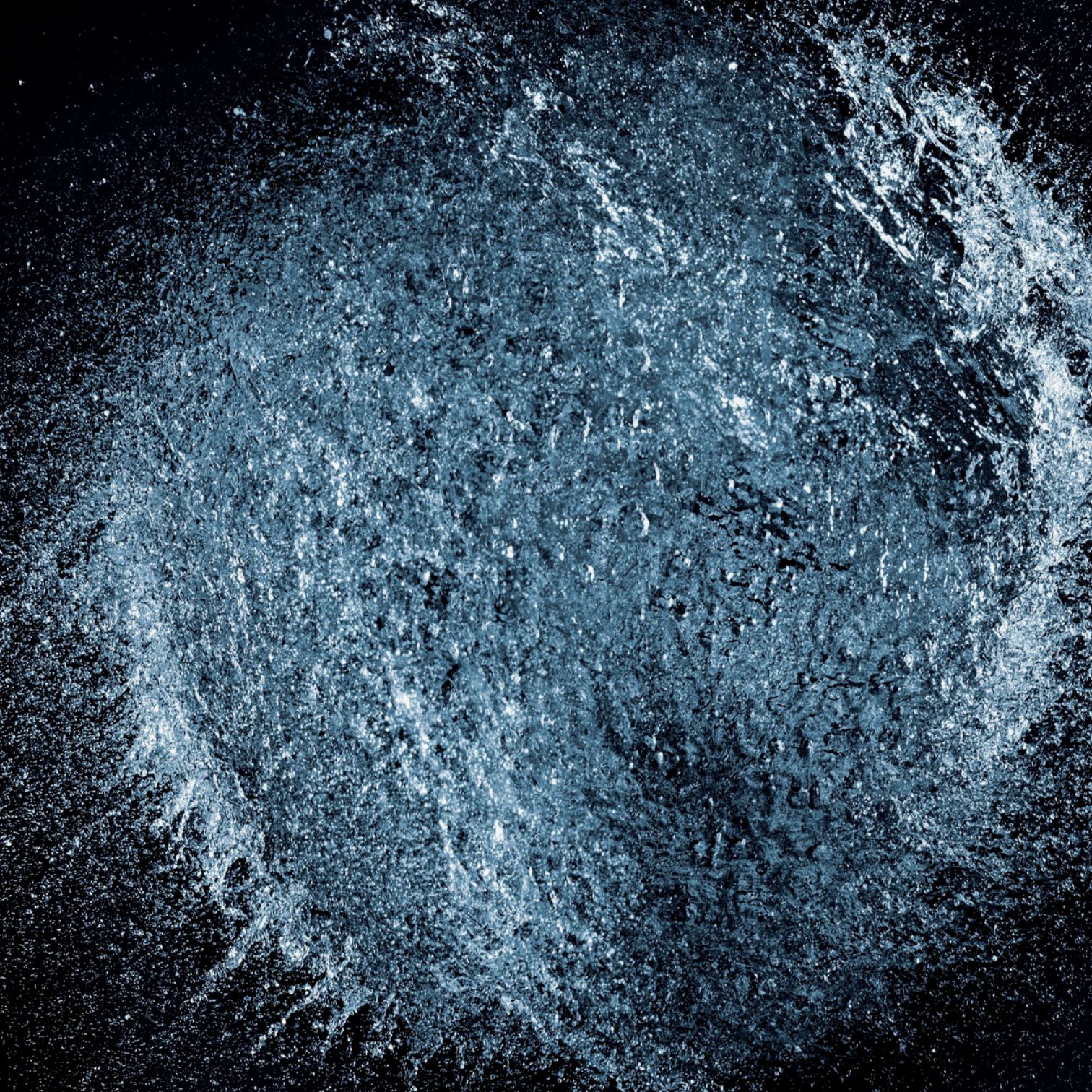





Presentado en caja transparente PET 100% reciclable



Grifo para fregadero 17 cm

· Volante grafilado en latón cromado · Aireador M 24/100

Ref.	Tipo	Embalaje	Uds.	Precio u.
6824	Índice azul	Caja	10 u.	24,650 €
6834	Índice rojo	Caja	10 u.	24,650 €



Grifo para fregadero 15 cm

· Volante grafilado en latón cromado

Ref.	Tipo	Embalaje	Uds.	Precio u.
3013	Índice azul	Bolsa ind.	10 u.	16,994 €
30131	Índice azul	Skin	10 u.	17,694 €
3023	Índice rojo	Bolsa ind.	10 u.	16,994 €
30231	Índice rojo	Skin	10 u.	17,694 €

7



Grifo para lavadora un mando

· Volante grafilado en latón cromado

Ref.	Tipo	Embalaje	Uds.	Precio u.
3010	Índice azul	Caja	10 u.	13,970 €
3016	Índice rojo	Caja	10 u.	13,970 €



Ideal para espacios reducidos

Grifo mini para lavadora y lavavajillas un mando

· Volante grafilado en latón cromado

Ref.	Embalaje	Uds.	Precio u.
3014	Bolsa ind.	5 u.	18,156 €
30141	Skin	5 u.	18,856 €

Sistema tradicional



El caudal de agua es repartido de forma desigual en las salidas, causando una durabilidad inferior de las monturas

Sistema Duchaflex®

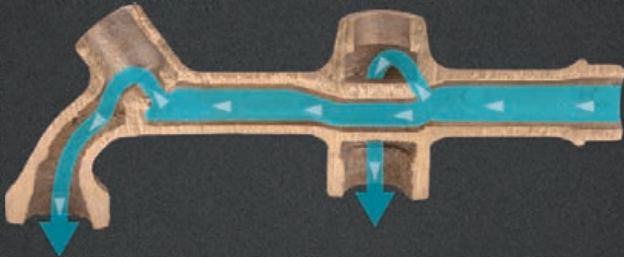

El caudal de agua es repartido de forma proporcional en ambas salidas, logrando una distribución uniforme del agua



Todos los grifos de lavadora y lavavajillas de dos mandos están fabricados con el sistema de distribución del agua Duchaflex®



Aireador incorporado

NUEVO EMBALAJE



Grifo para lavadora dos mandos

· Volante grafilado en latón cromado · Aireador H 22/100

Ref.	Embalaje	Uds.	Precio u.
3011	Caja	10 u.	28,810 €



NUEVO EMBALAJE



Grifo para lavadora y lavavajillas dos mandos

· Volante grafilado en latón cromado

Ref.	Embalaje	Uds.	Precio u.
3012	Caja	10 u.	28,280 €



Grifo fregadero mural dos mandos con caño giratorio

· Caño de 200 mm con aireador H 22/100 · Volante grafilado en latón cromado

Ref.	Tipo	Embalaje	Uds.	Precio u.
3594	Económico	Caja	2 u.	49,500 €
35942	Ahorro de agua	Caja	2 u.	51,500 €



Grifo fregadero repisa dos mandos con caño giratorio

· Volante grafilado en latón cromado · Aireador H 22/100

Ref.	Tipo	Embalaje	Uds.	Precio u.
3994	Económico	Caja	2 u.	39,500 €
39942	Ahorro de agua	Caja	2 u.	41,500 €

7



Grifo mural para fregadero un mando y caño giratorio

· Caño de 200 mm con aireador H 22/100 · Volante grafilado en latón cromado

Ref.	Tipo	Embalaje	Uds.	Precio u.
3494	Económico	Caja	4 u.	24,905 €
34941	Económico	Skin	4 u.	25,505 €
34942	Ahorro de agua	Caja	4 u.	26,905 €



Grifo repisa para fregadero un mando con caño giratorio

· Volante grafilado en latón cromado · Aireador H 22/100

Ref.	Tipo	Embalaje	Uds.	Precio u.
8120	Económico	Caja	4 u.	28,970 €
81202	Ahorro de agua	Caja	4 u.	30,970 €



Grifo para lavadora

· Volante grafilado en latón cromado

Ref.	Tipo	Embalaje	Uds.	Precio u.
3729	Índice azul	Bolsa ind.	5 u.	25,065 €
3739	Índice rojo	Bolsa ind.	5 u.	25,065 €



Volante grafilado

· Fabricado en latón cromado

Ref.	Tipo	Embalaje	Uds.	Precio u.
6851	Volante	Caja	10 u.	5,105 €
68511	Tapa índice azul	Bolsa	10 u.	1,250 €
68512	Tapa índice rojo	Bolsa	10 u.	1,250 €



Grifo 17 cm. para fregadero

· Volante walter · Aireador M 24/100

Ref.	Producto	Embalaje	Uds.	Precio u.
5100	Índice azul	Bolsa	10 u.	21,950 €
5110	Índice rojo	Bolsa	10 u.	21,950 €



Grifo 15 cm. para fregadero

· Volante walter

Ref.	Producto	Embalaje	Uds.	Precio u.
5200	Índice azul	Bolsa ind.	10 u.	15,505 €
5210	Índice rojo	Bolsa ind.	10 u.	15,505 €

NUEVO
DISEÑO



90 mm

Grifo para lavadora un mando

· Volante walter

Ref.	Producto	Embalaje	Uds.	Precio u.
5400	Índice azul	Bolsa	10 u.	12,150 €
5410	Índice rojo	Bolsa	10 u.	12,150 €



Ideal para
espacios reducidos

Grifo mini para lavadora y lavavajillas un mando

· Volante walter

Ref.	Producto	Embalaje	Uds.	Precio u.
5500	Índice azul	Bolsa ind.	5 u.	16,875 €

7



150 mm

Aireador
incorporado

Grifo para lavadora un mando

· Volante grafilado en latón cromado · Aireador H 22/100

Ref.	Embalaje	Uds.	Precio u.
5250	Bolsa ind.	10 u.	24,970 €



150 mm

Grifo para lavadora y lavavajillas dos mandos

· Volante walter

Ref.	Embalaje	Uds.	Precio u.
5300	Bolsa ind.	10 u.	24,850 €



Grifo mural para fregadero un mando con caño giratorio

· Caño de 200 mm con aireador H 22/100 · Volante walter

Ref.	Embalaje	Uds.	Precio u.
5600	Caja	4 u.	22,995 €



Grifo repisa para fregadero un mando con caño giratorio

· Volante walter · Aireador H 22/100

Ref.	Embalaje	Uds.	Precio u.
5700	Caja	4 u.	25,863 €



Grifo para lavabo

· Volante walter

Ref.	Producto	Embalaje	Uds.	Precio u.
5800	Índice azul	Bolsa ind.	5 u.	23,150 €
5900	Índice rojo	Bolsa ind.	5 u.	23,150 €



Volante walter

· Fabricado en ABS

Ref.	Producto	Embalaje	Uds.	Precio u.
5000	Volante	Bolsa	10 u.	2,950 €
50001	Placa índice azul	Bolsa	10 u.	0,905 €
50002	Placa índice rojo	Bolsa	10 u.	0,905 €



Grifo para fregadero 17 cm

· Volante en metacrilato · Aireador M 24/100

Ref.	Tipo	Embalaje	Uds.	Precio u.
3002	Índice azul	Bolsa	10 u.	20,995 €
3003	Índice rojo	Bolsa	10 u.	20,995 €



Grifo para fregadero 15 cm

· Volante en metacrilato

Ref.	Tipo	Embalaje	Uds.	Precio u.
3008	Índice azul	Bolsa ind.	10 u.	14,605 €
3001	Índice rojo	Bolsa ind.	10 u.	14,605 €

7

NUEVO
DISEÑO



Grifo para lavadora un mando

· Volante en metacrilato

Ref.	Tipo	Embalaje	Uds.	Precio u.
3000	Índice azul	Bolsa	10 u.	11,250 €
3040	Índice rojo	Bolsa	10 u.	11,250 €



Ideal para espacios reducidos

Grifo para lavadora y lavavajillas un mando

· Volante en metacrilato

Ref.	Embalaje	Uds.	Precio u.
2990	Bolsa ind.	5 u.	15,975 €



Grifo para lavadora dos mandos

· Volantes en metacrilato · Aireador H 22/100

Ref.	Embalaje	Uds.	Precio u.
3007	Bolsa	10 u.	23,570 €



Grifo para lavadora y lavavajillas dos mandos

· Volantes en metacrilato

Ref.	Embalaje	Uds.	Precio u.
3418	Bolsa	10 u.	23,450 €



Grifo para fregadero mural un mando con caño giratorio

· Caño de 200 mm con aireador H 22/100 · Volante en metacrilato

Ref.	Embalaje	Uds.	Precio u.
3009	Caja	4 u.	21,500 €



Grifo para fregadero repisa un mando con caño giratorio

· Volante en metacrilato · Aireador H 22/100

Ref.	Embalaje	Uds.	Precio u.
2980	Caja	4 u.	24,975 €



Grifo para lavabo

· Volante en metacrilato

Ref.	Tipo	Embalaje	Uds.	Precio u.
2970	Índice azul	Bolsa ind.	5 u.	22,250 €
2960	Índice rojo	Bolsa ind.	5 u.	22,250 €



Volante en metacrilato

Ref.	Tipo	Embalaje	Uds.	Precio u.
6429	Volante	Bolsa	10 u.	2,105 €
64291	Índice azul	Bolsa	10 u.	0,995 €
64292	Índice rojo	Bolsa	10 u.	0,995 €

7



Juego de fijación para grifería

· Rosca M 8/100

Ref.	Embalaje	Uds.	Precio u.
4250	Skin	12 u.	3,050 €



Conexión recambio para grifería

· Fabricado en acero inox AISI 304 · Longitud 30 cm · Ø 13 mm

Ref.	Embalaje	Uds.	Precio u.
4181	Bolsa	10 u.	2,595 €
41811	Skin	10 u.	2,980 €



Caño 200 mm horizontal

- Fabricado en latón cromado · Aireador H 22/100 incorporado
- Tubo de Ø 18 mm

Ref.	Embalaje	Uds.	Precio u.
8075	Skin	1 u.	9,450 €



Caño 180 mm vertical

- Fabricado en latón cromado · Aireador H 22/100 incorporado
- Tubo de Ø 18 mm

Ref.	Embalaje	Uds.	Precio u.
8085	Skin	1 u.	9,475 €





8



Excéntrica medidas estándar

· Medidas estandarizadas · Roscas 1/2" G. x 3/4" G. · 15 mm de longitud · Fabricada en latón

Ref.	Embalaje	Uds.	Precio u.
3035	Bolsa	12 u.	2,805 €



Excéntrica medidas especiales

· Roscas 1/2" G. x 3/4" G. · 25 mm de longitud · Fabricada en latón

Ref.	Embalaje	Uds.	Precio u.
5610	Bolsa	12 u.	4,456 €



Florón medidas estándar 3/4" G.

· Fabricado en acero inoxidable AISI 304

Ref.	Embalaje	Uds.	Precio u.
3033	Bolsa	12 u.	1,605 €



Florón medidas especiales rosca 3/4" G.

· Fabricado en acero inoxidable AISI 304

Ref.	Embalaje	Uds.	Precio u.
3019	Bolsa	12 u.	3,105 €



Juego excéntricas estandarizadas

· Compuesto por 2 x ref. 3035, 2 x ref. 3030 y 2x juntas anchas 3/4" G. en EPDM 70° (ref. 3468)

Ref.	Embalaje	Uds.	Precio u.
3380	Bolsa ind.	12 u.	4,950 €
33801	Skin	10 u.	5,550 €



Juego excéntricas especiales

· Compuesto por 2 x ref. 5610, 2 x ref. 3019 y 2x juntas anchas 3/4" G. en EPDM 70° (ref. 3468)

Ref.	Embalaje	Uds.	Precio u.
3030	Bolsa ind.	10 u.	11,950 €
30301	Skin	6 u.	12,550 €

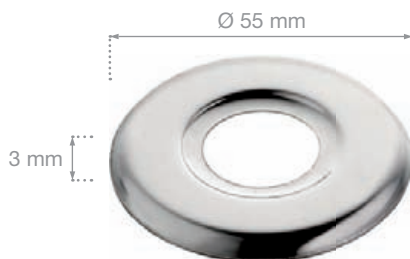

Florón inox ondulado 1/2" G.

· Fabricado en acero inoxidable AISI 304

Ref.	Embalaje	Uds.	Precio u.
5459	Caja	125 u.	0,215 €



Florón inox bombeado 1/2" G.

· Fabricado en acero inoxidable AISI 304

Ref.	Embalaje	Uds.	Precio u.
3034	Caja	125 u.	0,215 €



Florón inox bombeado $\text{Ø } 1/2'' \text{ G.}$

· Fabricado en acero inoxidable AISI 304

Ref.	Embalaje	Uds.	Precio u.
6081	Caja	50 u.	1,559 €

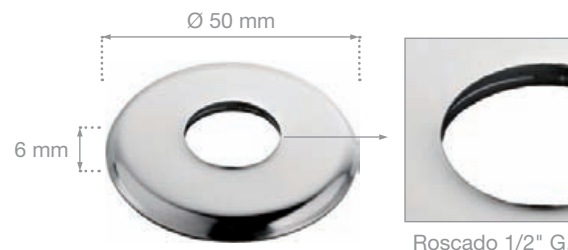

Florón inox bombeado con rosca $1/2'' \text{ G.}$

· Fabricado en acero inoxidable AISI 304

Ref.	Embalaje	Uds.	Precio u.
3029	Caja	60u.	0,415 €



Florón inox bombeado $\text{Ø } 3/4'' \text{ G.}$

· Fabricado en acero inoxidable AISI 304

Ref.	Embalaje	Uds.	Precio u.
4811	Caja	60 u.	0,395 €



Florón doble bombeado $\text{Ø } 32 \text{ mm}$

· Fabricado en latón cromado

Ref.	Embalaje	Uds.	Precio u.
7576	Caja	25 u.	1,565 €



Florón doble bombeado $\varnothing 32 \text{ mm}$

· Fabricado en latón cromado

Ref.	Embalaje	Uds.	Precio u.
7476	Caja	12 u.	3,521 €



Florón doble bombeado $\varnothing 40 \text{ mm}$

· Fabricado en latón cromado

Ref.	Embalaje	Uds.	Precio u.
7276	Caja	12 u.	3,596 €

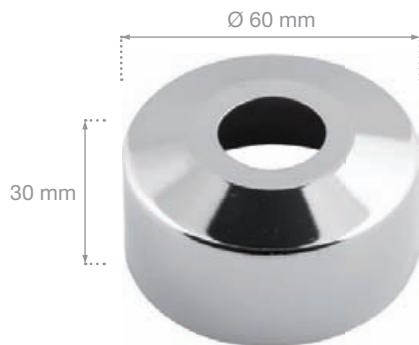

Florón doble bombeado $\varnothing 1/2" \text{ G.}$

· Fabricado en latón cromado

Ref.	Embalaje	Uds.	Precio u.
5559	Caja	12 u.	2,704 €

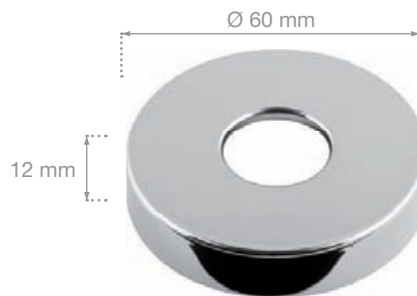

Florón slim $\varnothing 1/2" \text{ G.}$

· Fabricado en latón cromado

Ref.	Embalaje	Uds.	Precio u.
5575	Caja	12 u.	1,945 €





9

Aireadores Duchaflex



Los aireadores Duchaflex® están homologados según las normas SVGW (Suiza), TUV (Alemania) y CSTB (Francia)

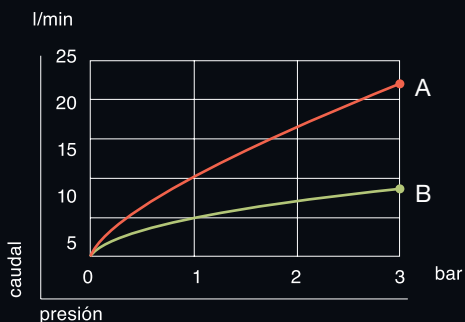

A - Consumo de agua aireador convencional
 B - Consumo de agua aireador ahorro de agua Duchaflex



Video demostración del ahorro de agua de los aireadores Duchaflex®.

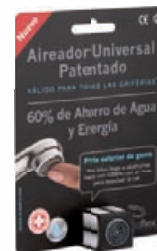

Aireador Universal 9500

PVP normal: ~~6,500 €~~

PVP en expositor: 5,910 €



Expositor aireador universal Snowlim

· Expositor de sobremesa con capacidad para 12 uds. de ref. 9500

Ref.	Producto	Embalaje	Uds.	Precio u.
100500	Expositor + 24 u. 9500	Caja	1 u.	141,840 €



Filtro Snowlim
Si el filtro llega a obstruirse basta con rozarlo con el dedo para expulsar la cal

Universal
Incluye adaptador para grifos con rosca H 22/100



 Sistema Patentedo

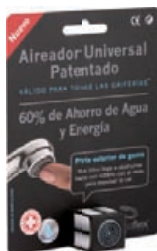

-  **AHORRO DE AGUA**
-  **UNIVERSAL**
-  **LIMPIAFÁCIL**
-  **ANTIBACTERIAS**
-  **ANTICAL**

Aireador universal Snowlim

· Hasta un 60% de ahorro de agua · Anticalcáreo · Antibacterias
· Filtro Snowlim

Ref.	Rosca	Embalaje	Uds.	Precio u.
9500	M 24/100 y H 22/100	Blister	12 u.	6,500 €



-  **AHORRO DE AGUA**
-  **LIMPIAFÁCIL**
-  **ANTIBACTERIAS**
-  **ANTICAL**

Aireador ahorrador de agua Snowlim

· Hasta un 60% de ahorro de agua · Anticalcáreo · Antibacterias
· Filtro Snowlim

Ref.	Rosca	Embalaje	Uds.	Precio u.
7800	H 22/100	Blister	12 u.	5,950 €



-  **AHORRO DE AGUA**
-  **LIMPIAFÁCIL**
-  **ANTIBACTERIAS**
-  **ANTICAL**

Aireador universal Snowlim

· Hasta un 60% de ahorro de agua · Anticalcáreo · Antibacterias
· Filtro Snowlim

Ref.	Rosca	Embalaje	Uds.	Precio u.
7800	M 24/100	Blister	12 u.	5,950 €



Ideal para espacios públicos



Antirrobo



Aireador Snowlim antirrobo

- Instalación con llave de seguridad · Anticalcáreo · Antibacterias
- Rosca M 24/100

Ref.	Producto	Embalaje	Uds.	Precio u.
9900	Espumante	Caja	1 u.	8,500 €
9950	Llave de instalación	Caja	1 u.	1,705 €



Simple instalación entre el grifo y el flexo de ducha



Ahorrador de agua y compensador de presión para ducha y bañera

- Rosca M 1/2" G. x H 1/2" G. · Hasta un 70% de ahorro de agua
- Anticalcáreo · Antibacterias

Ref.	Embalaje	Uds.	Precio u.
8200	Blister	8 u.	5,950 €

Ref. 7010



Ref. 8200
x 1 uds.



Ref. 7700
x 1 uds.



Ref. 7800
x 1 uds.

Ref. 7025



Ref. 7800
x 2 uds.



Kits ahorro de agua Snowlim

- Espumantes con filtro Snowlim · Anticalcáreos · Antibacterias

Ref.	Embalaje	Uds.	Precio u.
7010	Blister	8 u.	13,950 €
7025	Blister	8 u.	10,500 €



Ref. 1519



Ref. 1518



Aireador económico ahorrador de agua

Ref.	Roca	Embalaje	Uds.	Precio u.
1518	M 24/100	Blister	12 u.	2,450 €
1519	H 22/100	Blister	12 u.	2,450 €



Ref. 1521/1522



Ref. 1511/1512



Aireador económico

Ref.	Rosca	Embalaje	Uds.	Precio u.
1511	M 24/100	Blister	15 u.	1,532 €
1521	H 22/100	Caja	36 u.	1,167 €
1512	M 24/100	Blister	15 u.	1,532 €
1522	H 22/100	Caja	27 u.	1,167 €



Ref. 7015



Ref. 8200
x 1 uds.



Ref. 1519
x 1 uds.



Ref. 1518
x 1 uds.

Ref. 7030



Ref. 1518
x 2 uds.



Kits ahorro de agua económicos

Ref.	Embalaje	Uds.	Precio u.
7015	Blister	8 u.	9,950 €
7030	Blister	8 u.	4,250 €



Ref. 1530



Ref. 1525



Filtro rompechorro

Ref.	Rosca	Embalaje	Uds.	Precio u.
1530	M 24/100	Blister	15 u.	1,105 €
1525	H 22/100	Blister	15 u.	1,105 €

Aireador económico oro

Ref.	Rosca	Embalaje	Uds.	Precio u.
1516	M 24/100	Blister	1 u.	4,750 €
1517	H 22/100	Blister	1 u.	4,750 €



Ref. 3970

Ref. 6815



Aireador para bañera

· Rosca M 28/100

Ref.	Embalaje	Uds.	Precio u.
1515	Blister	12 u.	3,195 €
3633	Caja	15 u.	1,812 €

Aireadores con rótula para bidé

Ref.	Producto	Embalaje	Uds.	Precio u.
3975	Ahorro de agua M 24/100	Blister	6 u.	6,250 €
6810	Ahorro de agua H 22/100	Blister	6 u.	6,250 €
3970	Económico M 24/100	Blister	6 u.	4,950 €
6815	Económico H 22/100	Blister	6 u.	4,950 €



Fabricado en material flexible que permite rociar cualquier rincón del fregadero



- Revestimiento en PVC transparente que protege de la cal, el moho y la suciedad.
- Tratamiento de metalización cromado para crear un efecto estético especial.
- Trenzado de 24 hilos en poliéster TIT 1000. Extraordinaria resistencia a altas temperaturas y presiones.
- Tubo interno en PVC bajo normativa NSF 61. Certificado de higiene del Instituto Pasteur de París.



Aireador flexible para cocina

- Hasta un 60% de ahorro de agua · Anticalcáreo · Antibacterias
- Válido para roscas M24/100 y H 22/100 · Filtro Snowlim

Ref.	Embalaje	Uds.	Precio u.
6971	Blister	8 u.	12,950 €



Rótula orientable que permite rociar cualquier rincón del fregadero



Dos posiciones



Filtro desmontable para limpieza



Rociador dos posiciones para cocina

- Hasta un 65% de ahorro de agua · Anticalcáreo · Antibacterias
- Válido para roscas M24/100 y H 22/100

Ref.	Embalaje	Uds.	Precio u.
7300	Blister	6 u.	13,500 €



Aireador ahorrador de agua rosca H 16/100
· Grifería minimalista

Ref.	Embalaje	Uds.	Precio u.
9030	Blister	6 u.	4,550 €



Aireador ahorrador de agua rosca M 18/100
· Grifería minimalista

Ref.	Embalaje	Uds.	Precio u.
9040	Blister	6 u.	4,550 €



Aireador ahorrador de agua rosca H 3/8" G.
· Grifería minimalista

Ref.	Embalaje	Uds.	Precio u.
9035	Blister	6 u.	4,550 €



Filtro ahorro de agua económico

Ref.	Embalaje	Uds.	Precio u.
3004	Blister	12 u.	2,185 €



Junta recambio ancha para espumante

- Válida para los aireadores 7800, 1518, 1511, 1521, 1516 y 3670
- Fabricada en EPDM 70°

Ref.	Embalaje	Uds.	Precio u.
78002	Caja	50 u.	0,250 €



Junta recambio ancha para espumante

- Válida para los aireadores 7700, 1519, 1512, 1522, y 6815
- Fabricada en EPDM 70°

Ref.	Embalaje	Uds.	Precio u.
77002	Caja	50 u.	0,250 €



Junta recambio ancha para espumante

- Válida para los aireadores 1515 y 3633 · Fabricada en EPDM 70°

Ref.	Embalaje	Uds.	Precio u.
151502	Caja	50 u.	0,250 €



Junta recambio ancha para espumante

- Válida para los aireadores 8200 y 6971 · Fabricada en EPDM 70°

Ref.	Embalaje	Uds.	Precio u.
820002	Caja	50 u.	0,250 €



Reducción M 24/100 x M 3/4" G.

· Fabricada en latón cromado

Ref.	Embalaje	Uds.	Precio u.
7900	Blister	12 u.	4,850 €



Reducción H 22/100 x M 3/4" G.

· Fabricada en latón cromado

Ref.	Embalaje	Uds.	Precio u.
7925	Blister	12 u.	4,850 €



Reducción M 1/2" G. x M 24/100

· Fabricada en latón cromado

Ref.	Embalaje	Uds.	Precio u.
7950	Blister	12 u.	4,450 €



Reducción H 1/2" G. x M 24/100

· Fabricada en latón cromado

Ref.	Embalaje	Uds.	Precio u.
7975	Blister	12 u.	4,900 €



Reducción M 24/100 x M 22/100

· Fabricada en latón

Ref.	Embalaje	Uds.	Precio u.
7045	Blister	12 u.	4,750 €



Reducción M 24/100 x M 22/100

· Fabricada en plástico

Ref.	Embalaje	Uds.	Precio u.
7970	Blister	12 u.	2,350 €



Reducción M 1/2" G. x H 22/100

· Fabricada en latón cromado

Ref.	Embalaje	Uds.	Precio u.
7020	Blister	12 u.	4,350 €



Todas las reducciones están presentadas en Blister





10



Plomo macizo

Equipo completo T-A económico

- Descarga de plomo (ref. 3123) · Flotador silencioso (ref. 3139)
- Palanca con soporte de hierro (ref. 6311) · Boya porexpan 3/8" G.
- Tirador WC blanco (ref. 3147) · Juego de tornillos y juntas

Ref.	Embalaje	Uds.	Precio u.
3315	Caja	4 u.	26,315 €

Equipo completo T-A normal

- Descarga de plomo reforzada (ref. 3124) · Flotador silencioso (ref. 3139)
- Palanca con soporte de hierro (ref. 6311) · Boya porexpan 3/8" G.
- Tirador WC blanco (ref. 3147) · Juego de tornillos y juntas

Ref.	Embalaje	Uds.	Precio u.
7274	Caja	4 u.	28,500 €



Equipo completo T-A reforzado

· Descarga de plomo reforzada (ref. 3124) · Palanca con soporte de latón fundición (ref. 3144) · Flotador silencioso (ref.3139) · Tirador WC blanco (ref. 3147) · Boya porexpan 3/8" G. · Juego de tornillos y juntas

Ref.	Embalaje	Uds.	Precio u.
7275	Caja	4 u.	31,500 €



Descarga de plomo T-A económica

· Junta de cierre con doble remache que evita deslizamientos de tubo · Rosca estandarizada · Anilla reforzada Ø 37 mm

Ref.	Embalaje	Uds.	Precio u.
3123	Caja	10 u.	16,500 €



Descarga de plomo T-A reforzada

· Junta de cierre con doble remache que evita deslizamientos de tubo · Rosca estandarizada · Anilla reforzada Ø 37 mm · Plomo totalmente macizo

Ref.	Embalaje	Uds.	Precio u.
3124	Caja	10 u.	18,900 €



Descarga de muelle T-A

· Junta de cierre con doble remache que evita deslizamientos de tubo · Rosca estandarizada · Anilla reforzada Ø 37 mm · Muelle de acero inoxidable AISI 304

Ref.	Embalaje	Uds.	Precio u.
3125	Caja	10 u.	16,750 €



Flotadores silenciosos

Ref.	Producto	Embalaje	Uds.	Precio u.
3139	1 - T-A 3/8" G.	Bolsa	20 u.	4,695 €
3140	2 - T-B 3/8" G.	Bolsa	10 u.	5,535 €



Anilla recambio reforzada

· Para descargas de tanque alto de plomo o muelle

Ref.	Embalaje	Uds.	Precio u.
31242	Caja	25 u.	0,825 €



Palancas WC

Ref.	Producto	Embalaje	Uds.	Precio u.
6311	1 - Económica	Bolsa	20 u.	1,357 €
3144	2 - Reforzada	Bolsa	20 u.	3,410 €



Boya porexpan

Ref.	Producto	Embalaje	Uds.	Precio u.
2821	3/8" G. - Ø 90 mm	Caja	25 u.	0,738 €
3266	1/2" G. - Ø 110 mm	Caja	25 u.	1,295 €



Junta plana para racor dos piezas descarga de plomo o muelle T-A

Ref.	Embalaje	Uds.	Precio u.
3277	Bolsa	50 u.	0,179 €



Junta semicónica 1" 1/4 WC T-A

Ref.	Embalaje	Uds.	Precio u.
3279	Caja	35 u.	0,662 €



Junta plana blanca 1" 1/4 WC T-A

Ref.	Embalaje	Uds.	Precio u.
3280	Caja	50 u.	0,189 €



ACERO INOXIDABLE

Juego de tornillos para WC

· Fabricados en acero inoxidable · Rosca M 5 x 78 mm · Guías en polipropileno · Tacos incluidos

Ref.	Embalaje	Uds.	Precio u.
3429	Bolsa ind.	50 u.	2,542 €
34291	Skin	50 u.	2,995 €

NUEVO
DISEÑO



Juego de fijaciones laterales para WC

· Rosca M 6 · Guías de polipropileno · Tacos incluidos

Ref.	Embalaje	Uds.	Precio u.
3390	Bolsa ind.	12 u.	3,550 €
33901	Skin	10 u.	4,150 €



ACERO INOXIDABLE

Largo
especial

Juego de fijación para cisterna

· Tornillos con rosca M 6 x 90 mm en acero inoxidable · Arandelas y tuercas en acero inoxidable

Ref.	Embalaje	Uds.	Precio u.
4756	Bolsa ind.	25 u.	2,835 €
47561	Skin	25 u.	3,235 €



Juego de tornillos para lavabo

· Rosca M 8 x 100 mm · Guías de polipropileno · Tacos incluidos

Ref.	Embalaje	Uds.	Precio u.
3732	Bolsa ind.	25 u.	1,795 €
37321	Skin	15 u.	2,295 €



ACERO INOXIDABLE

Juego de fijación para cisterna con junta doble cónica

· Junta en caucho de Ø 110 x 58 mm (ref. 3287) · Tornillos con rosca M 6 x 90 mm en acero inoxidable · Arandelas y tuercas en acero inoxidable

Ref.	Embalaje	Uds.	Precio u.
9400	Bolsa ind.	12 u.	4,195 €
94001	Skin	15 u.	4,695 €



ACERO INOXIDABLE

Juego de fijación para cisterna con junta

· Junta en NBR 90° de Ø 110 x 95 mm (ref. 9200) · Tornillos con rosca M 6 x 90 mm en acero inoxidable · Arandelas y tuercas en acero inoxidable

Ref.	Embalaje	Uds.	Precio u.
9300	Bolsa ind.	12 u.	4,457 €
93001	Skin	15 u.	4,955 €



ACERO INOXIDABLE

Tornillos de sujeción para palanca T-A

· Roscas M 4/100 x 40 mm

Ref.	Embalaje	Uds.	Precio u.
3409	Caja	50 u.	0,357 €



Juntas recambio

· Fabricadas en NBR 90° / caucho

Ref.	Producto	Embalaje	Uds.	Precio u.
3287	1 - Cónica 110 x 58 mm	Caja	20 u.	1,258 €
9200	2 - Labiada 110 x 95 mm	Caja	24 u.	2,075 €



Tirador plano para cisterna T-A

· Fabricado en metacrilato · Cadena incluida

Ref.	Embalaje	Uds.	Precio u.
3148	Bolsa ind.	12 u.	3,616 €
31481	Skin	15 u.	4,216 €



Tirador anilla para cisterna T-A

· Fabricado en metacrilato · Cadena incluida

Ref.	Acabado	Embalaje	Uds.	Precio u.
3151	Blanco	Bolsa ind.	12 u.	3,911 €
31511	Blanco	Skin	12 u.	4,511 €
3152	Transparente	Bolsa ind.	15 u.	3,911 €
31521	Transparente	Skin	15 u.	4,511 €

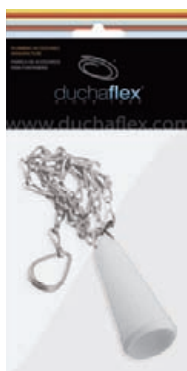

Tirador redondo para cisterna T-A

· Cadena incluida

Ref.	Embalaje	Uds.	Precio u.
3147	Bolsa ind.	12 u.	2,047 €
31471	Skin	15 u.	2,647 €



Eje portarollos

Ref.	Embalaje	Uds.	Precio u.
3196	Bolsa ind.	12 u.	0,621 €
31961	Skin	15 u.	1,021 €



Tirador para cisterna T-B con varilla recta

· Pomo en plástico

Ref.	Embalaje	Uds.	Precio u.
3154	Bolsa ind.	12 u.	2,265 €
31541	Skin	15 u.	2,765 €



Tirador para cisterna T-B con varilla c

· Pomo en plástico

Ref.	Embalaje	Uds.	Precio u.
3156	Bolsa ind.	12 u.	2,265 €
31561	Skin	15 u.	2,765 €



Tirador para cisterna T-B con varilla recta

· Pomo en latón cromado

Ref.	Embalaje	Uds.	Precio u.
3155	Bolsa ind.	12 u.	3,040 €
31551	Skin	15 u.	3,540 €



Tirador para cisterna con varilla curva

· Pomo en latón cromado

Ref.	Embalaje	Uds.	Precio u.
3157	Bolsa ind.	12 u.	3,040 €
31571	Skin	15 u.	3,540 €



Extensible
de 270 a 350 mm

Descarga completa para T-B

· Para cisternas con rosca tipo "Roca" · Junta semicónica incluida

Ref.	Embalaje	Uds.	Precio u.
3126	Bolsa	15 u.	5,088 €



Extensible
de 270 a 350 mm

Descarga sin base para T-B

· Para cisternas con rosca tipo "Roca"

Ref.	Embalaje	Uds.	Precio u.
3127	Bolsa	15 u.	3,872 €



Boya sifónica recambio "Lorentina"

Ref.	Embalaje	Uds.	Precio u.
2811	Bolsa	6 u.	4,650 €



Skin de 3 uds.

Junta "sombrero" para descarga T-B

· Fabricada en caucho natural

Ref.	Embalaje	Uds.	Precio u.
3393	Caja	50 u.	0,772 €
33931	Skin	15 u.	2,995 €

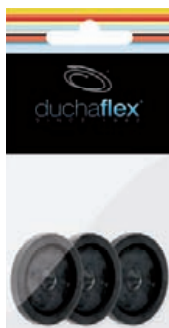

Skin de 3 uds.

Junta cierre flotador vertical "Roca"

Ref.	Embalaje	Uds.	Precio u.
3491	Bolsa	50 u.	0,545 €
34911	Skin	12 u.	2,451 €

Ø 73 x Ø 23 mm



Skin de 3 uds.

Junta especial descargas T-B Roca

Ref.	Embalaje	Uds.	Precio u.
6644	Caja	100 u.	0,422 €
66441	Skin	20 u.	2,300 €

Ø 68 x Ø 33 mm



Skin de 3 uds.

Junta especial descargas T-B Roca/Jacob Delafon

Ref.	Embalaje	Uds.	Precio u.
4038	Caja	100 u.	0,495 €
40381	Skin	20 u.	2,350 €

Ø 66 x Ø 17 mm



Skin de 3 uds.

Junta especial para descargas T-B Roca

Ref.	Embalaje	Uds.	Precio u.
8900	Caja	100 u.	0,495 €
89001	Skin	20 u.	2,350 €







Asidero para bañera

- Fabricado en latón acabado cromado · Tubo de Ø 25 mm
- Placa sujeción de tubo de Ø 50 mm · Incluye 3 tornillos de acero inoxidable y tacos

Ref.	Embalaje	Uds.	Precio u.
1314	Skin	6 u.	27,995 €

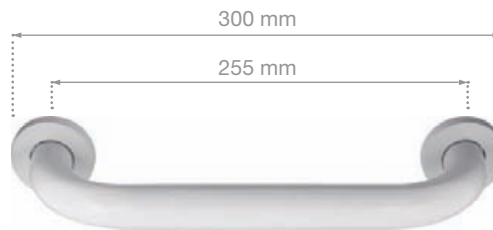

Asidero para bañera

- Fabricado en latón acabado color blanco · Tubo de Ø 25 mm
- Placa sujeción de tubo de Ø 50 mm · Incluye 3 tornillos de acero inoxidable y tacos

Ref.	Embalaje	Uds.	Precio u.
1318	Skin	6 u.	27,995 €



Roseta tapa agujeros cromada

- Fabricada en polipropileno de alta densidad

Ref.	Embalaje	Uds.	Precio u.
3627	Bolsa	25 u.	0,876 €
36271	Skin	12 u.	1,276 €



Roseta tapa agujeros blanca

- Fabricada en polipropileno de alta densidad

Ref.	Embalaje	Uds.	Precio u.
3447	Bolsa	25 u.	0,876 €
34471	Skin	12 u.	1,276 €



ACERO INOXIDABLE

Rejilla para urinario

· Fabricada en acero inoxidable AISI 304

Ref.	Embalaje	Uds.	Precio u.
3202	Bolsa	10 u.	1,955 €



Montura universal visto

· Volante grafilado en latón

Ref.	Medida	Embalaje	Uds.	Precio u.
5320	16/150	Caja ind.	12 u.	8,652 €
4894	17/150	Caja ind.	12 u.	8,652 €
6442	18/150	Caja ind.	12 u.	8,652 €
5987	19/150	Caja ind.	12 u.	8,652 €
3490	20/150	Caja ind.	12 u.	8,652 €
7672	21/150	Caja ind.	12 u.	8,652 €
6143	22/150	Caja ind.	12 u.	8,652 €
3615	3/8" G.	Caja ind.	12 u.	8,652 €
3489	1/2" G.	Caja ind.	12 u.	8,652 €



Modelos homologados

Rejilla de ventilación

· Fabricada en aluminio · Esmaltada en color blanco

Ref.	Medidas	Embalaje	Uds.	Precio u.
3792	15 x 15 cm	Caja	50 u.	1,056 €
3793	17 x 17 cm	Caja	50 u.	1,414 €
3794	20 x 20 cm	Caja	50 u.	1,662 €



Montura universal empotrar

· Volante grafilado en latón

Ref.	Medida	Embalaje	Uds.	Precio u.
7674	16/150	Caja ind.	12 u.	10,352 €
7675	17/150	Caja ind.	12 u.	10,352 €
3808	18/150	Caja ind.	12 u.	10,352 €
3168	19/150	Caja ind.	12 u.	10,352 €
3807	20/150	Caja ind.	12 u.	10,352 €
6062	21/150	Caja ind.	12 u.	10,352 €
6138	22/150	Caja ind.	12 u.	10,352 €
7677	3/8" G.	Caja ind.	12 u.	10,352 €
7678	1/2" G.	Caja ind.	12 u.	10,352 €



12





Sistema de apertura/cierre que impide la pérdida de las juntas

Contiene las juntas anchas más habituales en las instalaciones de fontanería



3/8"
x 8 uds.

1/2"
x 12 uds.

3/4"
x 12 uds.

1"
x 3 uds.



1 1/4"
x 2 uds.

1 1/2"
x 2 uds.

Kit juntas indispensables anchas

· Fabricadas en EPDM 70° · Tolerancias según normas DIN 3771

Ref.	Embalaje	Uds.	Precio u.
6500	Caja ind.	10 u.	3,950 €



Contiene las juntas estrechas más habituales en las instalaciones de fontanería



3/8"
x 8 uds.

1/2"
x 12 uds.

3/4"
x 12 uds.

1"
x 3 uds.



1 1/4"
x 2 uds.

1 1/2"
x 2 uds.

Kit juntas indispensables estrechas

· Fabricadas en EPDM 70° · Tolerancias según normas DIN 3771

Ref.	Embalaje	Uds.	Precio u.
6600	Caja ind.	10 u.	3,950 €



Juntas planas anchas para racorería en skin de 10 uds.

· Fabricadas en EPDM 70° · Tolerancias DIN 3771

Ref.	Medida	Embalaje	Uds.	Precio u.
34991	3/8" - 14,5 x 8 x 2 mm	Skin	12 u.	0,952 €
36491	1/2" - 18 x 10 x 2 mm	Skin	12 u.	0,952 €
34681	3/4" - 24 x 13 x 3 mm	Skin	12 u.	1,039 €
40161	1" - 30 x 20 x 2,5 mm	Skin	12 u.	1,457 €
31941	1" 1/4 - 38 x 29 x 3 mm	Skin	12 u.	1,950 €
31981	1" 1/4 Plus - 39 x 27 x 2,5 mm	Skin	12 u.	2,975 €
31951	1" 1/2 - 45 x 30 x 3,5 mm	Skin	12 u.	2,150 €
86711	2" - 54 x 44 x 3 mm	Skin	12 u.	2,520 €
86751	2" Plus - 57 x 40 x 3 mm	Skin	12 u.	5,101 €



Juntas planas anchas para racorería a granel

· Fabricadas en EPDM 70° · Tolerancias DIN 3771

Ref.	Medida	Embalaje	Uds.	Precio u.
3499	3/8" - 14,5 x 8 x 2 mm	Bolsa	200 u.	0,051 €
3649	1/2" - 18 x 10 x 2 mm	Bolsa	200 u.	0,051 €
3468	3/4" - 24 x 13 x 3 mm	Bolsa	200 u.	0,059 €
4016	1" - 30 x 20 x 2,5 mm	Bolsa	200 u.	0,088 €
3194	1" 1/4 - 38 x 29 x 3 mm	Bolsa	200 u.	0,167 €
3198	1" 1/4 Plus - 39 x 27 x 2,5 mm	Bolsa	200 u.	0,235 €
3195	1" 1/2 - 45 x 30 x 3,5 mm	Bolsa	200 u.	0,175 €
8671	2" - 54 x 44 x 3 mm	Bolsa	50 u.	0,226 €
8675	2" Plus - 57 x 40 x 3 mm	Bolsa	50 u.	0,495 €



Juntas planas estrechas para racorería en skin de 10 uds.

· Fabricadas en EPDM 70° · Tolerancias DIN 3771

Ref.	Medida	Embalaje	Uds.	Precio u.
81731	3/8" - 14 x 10 x 2 mm	Skin	12 u.	0,952 €
36501	1/2" - 18 x 14 x 2 mm	Skin	12 u.	1,039 €
36511	3/4" - 23,5 x 19 x 2 mm	Skin	12 u.	1,155 €
36521	3/4" - 24 x 18 x 2 mm	Skin	12 u.	1,155 €
40151	1" - 30 x 24 x 2,5 mm	Skin	12 u.	1,390 €
32811	1" 1/4 - 35 x 30 x 2,5 mm	Skin	12 u.	1,950 €
61921	1" 1/2 - 44 x 37 x 2,5 mm	Skin	12 u.	2,235 €
83281	2" - 54 x 47 x 3,5 mm	Skin	12 u.	2,500 €
90801	7/8" - 27 x 22 x 2,5 mm	Skin	12 u.	1,395 €



Juntas planas estrechas para racorería a granel

· Fabricadas en EPDM 70° · Tolerancias DIN 3771

Ref.	Medida	Embalaje	Uds.	Precio u.
8173	3/8" - 14 x 10 x 2 mm	Bolsa	200 u.	0,051 €
3650	1/2" - 18 x 14 x 2 mm	Bolsa	200 u.	0,051 €
3651	3/4" - 23,5 x 19 x 2 mm	Bolsa	200 u.	0,059 €
3652	3/4" - 24 x 18 x 2 mm	Bolsa	200 u.	0,062 €
4015	1" - 30 x 24 x 2,5 mm	Bolsa	200 u.	0,086 €
3281	1" 1/4 - 35 x 30 x 2,5 mm	Bolsa	200 u.	0,167 €
6192	1" 1/2 - 44 x 37 x 2,5 mm	Bolsa	200 u.	0,199 €
8328	2" - 54 x 47 x 3,5 mm	Bolsa	50 u.	0,226 €
9080	7/8" - 27 x 22 x 2,5 mm	Bolsa	200 u.	0,115 €



Juntas anchas Klingerit en skin de 10 uds.

· Tolerancias DIN 3754 · Homologadas según KTW

· Fabricadas en FASIT 202

Ref.	Medida	Embalaje	Uds.	Precio u.
20501	3/8" - 14,8 x 9 x 2 mm	Skin	12 u.	1,188 €
20601	1/2" - 18,5 x 11 x 2 mm	Skin	12 u.	1,248 €
20701	3/4" - 24 x 12 x 2 mm	Skin	12 u.	1,582 €
20801	1" - 30 x 21 x 2 mm	Skin	12 u.	1,828 €
20901	1" 1/4 - 38,6 x 30 x 2 mm	Skin	12 u.	3,551 €
21601	1" 1/2 - 44,5 x 30 x 2 mm	Skin	12 u.	4,359 €
20301	2" - 56 x 43,5 x 2 mm	Skin	12 u.	5,965 €
20851	Radiador - 42 x 33 x 1 mm	Skin	12 u.	4,950 €

Juntas estrechas Klingerit en skin de 10 uds.

· Tolerancias DIN 3754 · Homologadas según KTW

· Fabricadas en FASIT 202

Ref.	Medida	Embalaje	Uds.	Precio u.
21101	3/8" - 14,5 x 10 x 2 mm	Skin	12 u.	1,248 €
21201	1/2" - 18,5 x 12 x 2 mm	Skin	12 u.	1,318 €
21301	3/4" - 24 x 18 x 2 mm	Skin	12 u.	1,582 €
21401	1" - 28,5 x 24 x 2 mm	Skin	12 u.	2,209 €
21501	1" 1/4 - 38,5 x 32 x 2 mm	Skin	12 u.	3,551 €
21001	1" 1/2 - 44,5 x 36 x 2 mm	Skin	12 u.	4,359 €



Juntas anchas Klingerit a granel

· Tolerancias DIN 3754 · Homologadas según KTW

· Fabricadas en FASIT 202

Ref.	Medida	Embalaje	Uds.	Precio u.
2050	3/8" - 14,8 x 9 x 2 mm	Bolsa	100 u.	0,049 €
2060	1/2" - 18,5 x 11 x 2 mm	Bolsa	100 u.	0,079 €
2070	3/4" - 24 x 12 x 2 mm	Bolsa	100 u.	0,109 €
2080	1" - 30 x 21 x 2 mm	Bolsa	100 u.	0,159 €
2090	1" 1/4 - 38,6 x 30 x 2 mm	Bolsa	100 u.	0,309 €
2160	1" 1/2 - 44,5 x 30 x 2 mm	Bolsa	100 u.	0,379 €
2030	2" - 56 x 43,5 x 2 mm	Bolsa	50 u.	0,519 €
2085	Radiador - 42 x 33 x 1 mm	Bolsa	100 u.	0,205 €

Juntas estrechas Klingerit a granel

· Tolerancias DIN 3754 · Homologadas según KTW

· Fabricadas en FASIT 202

Ref.	Medida	Embalaje	Uds.	Precio u.
2110	3/8" - 14,5 x 10 x 2 mm	Bolsa	100 u.	0,049 €
2120	1/2" - 18,5 x 12 x 2 mm	Bolsa	100 u.	0,069 €
2130	3/4" - 24 x 18 x 2 mm	Bolsa	100 u.	0,099 €
2140	1" - 28,5 x 24 x 2 mm	Bolsa	100 u.	0,149 €
2150	1" 1/4 - 38,5 x 32 x 2 mm	Bolsa	100 u.	0,309 €
2100	1" 1/2 - 44,5 x 36 x 2 mm	Bolsa	100 u.	0,379 €



Juntas anchas PTFE en skin de 10 uds.

Ref.	Medida	Embalaje	Uds.	Precio u.
21701	3/8" - 14 x 7 x 1,5 mm	Skin	12 u.	1,695 €
21801	1/2" - 18,5 x 11 x 1,5 mm	Skin	12 u.	1,918 €
21901	3/4" - 24 x 13 x 1,5 mm	Skin	12 u.	2,345 €
22001	1" - 30 x 20 x 1,5 mm	Skin	12 u.	2,545 €
22701	1" 1/4 - 39 x 30 x 1,5 mm	Skin	12 u.	3,405 €
22801	1" 1/2 - 45 x 37 x 1,5 mm	Skin	12 u.	3,550 €
22901	2" - 54 x 44 x 1,5 mm	Skin	12 u.	5,198 €

Juntas estrechas PTFE en skin de 10 uds.

Ref.	Medida	Embalaje	Uds.	Precio u.
22301	3/8" - 14,5 x 10 x 1,5 mm	Skin	12 u.	1,695 €
22401	1/2" - 18,5 x 14 x 1,5 mm	Skin	12 u.	1,918 €
22501	3/4" - 24 x 19 x 1,5 mm	Skin	12 u.	2,345 €
22601	1" - 30 x 24 x 1,5 mm	Skin	12 u.	2,545 €



Juntas anchas PTFE a granel

Ref.	Medida	Embalaje	Uds.	Precio u.
2170	3/8" - 14 x 7 x 1,5 mm	Bolsa	100 u.	0,128 €
2180	1/2" - 18,5 x 11 x 1,5 mm	Bolsa	100 u.	0,153 €
2190	3/4" - 24 x 13 x 1,5 mm	Bolsa	100 u.	0,193 €
2200	1" - 30 x 20 x 1,5 mm	Bolsa	100 u.	0,207 €
2270	1" 1/4 - 39 x 30 x 1,5 mm	Bolsa	100 u.	0,335 €
2280	1" 1/2 - 45 x 37 x 1,5 mm	Bolsa	100 u.	0,355 €
2290	2" - 54 x 44 x 1,5 mm	Bolsa	50 u.	0,578 €

Juntas estrechas PTFE a granel

Ref.	Medida	Embalaje	Uds.	Precio u.
2230	3/8" - 14,5 x 10 x 1,5 mm	Bolsa	100 u.	0,132 €
2240	1/2" - 18,5 x 14 x 1,5 mm	Bolsa	100 u.	0,149 €
2250	3/4" - 24 x 19 x 1,5 mm	Bolsa	100 u.	0,169 €
2260	1" - 30 x 24 x 1,5 mm	Bolsa	100 u.	0,226 €
2270	1" 1/4 - 39 x 30 x 1,5 mm	Bolsa	100 u.	0,335 €
2280	1" 1/2 - 45 x 37 x 1,5 mm	Bolsa	100 u.	0,335 €
2290	2" - 54 x 44 x 1,5 mm	Bolsa	50 u.	0,578 €

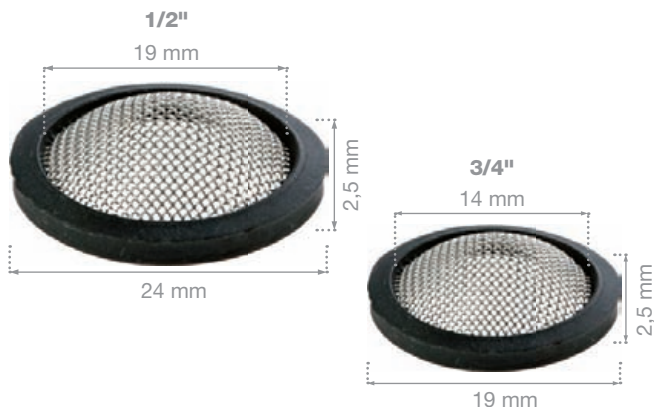

Junta goma plana con filtro

· Fabricada en EPDM 70° y acero inoxidable AISI 304 · Tolerancias DIN 3771

Ref.	Medida	Embalaje	Uds.	Precio u.
2600	1/2"	Caja	50 u.	0,579 €
2625	3/4"	Caja	50 u.	0,579 €



Junta goma plana con filtro en Skin 4 uds.

· Fabricada en EPDM 70° y acero inoxidable AISI 304 · Tolerancias DIN 3771

Ref.	Medida	Embalaje	Uds.	Precio u.
26001	1/2"	Skin	12 u.	2,850 €
26251	3/4"	Skin	12 u.	2,850 €



Juntas cónicas flexibles

· Fabricadas en PVC

Ref.	Medida	Embalaje	Uds.	Precio u.
3734	1 - Ø 32 mm	Bolsa	50 u.	0,213 €
4045	2 - Ø 40 mm	Bolsa	50 u.	0,213 €
3240	3 - Ø 40 / 32 mm	Bolsa	50 u.	0,330 €



Juntas cónicas flexibles en Skin 4 uds.

· Fabricadas en PVC

Ref.	Medida	Embalaje	Uds.	Precio u.
37341	1 - Ø 32 mm	Skin	12 u.	1,500 €
40451	2 - Ø 40 mm	Skin	12 u.	1,500 €
32401	3 - Ø 40 / 32 mm	Skin	12 u.	1,895 €



Juntas planas blancas

Ref.	Medida	Embalaje	Uds.	Precio u.
2300	3/8"	Caja	50 u.	0,128 €
2310	1/2"	Caja	50 u.	0,149 €
2320	3/4"	Caja	50 u.	0,176 €
2330	1"	Caja	50 u.	0,188 €
3280	1 1/4"	Caja	50 u.	0,189 €
3410	1 1/2"	Caja	50 u.	0,207 €
2340	2"	Caja	50 u.	0,236 €



Juntas planas blancas en Skin 3 uds.

Ref.	Medida	Embalaje	Uds.	Precio u.
23001	3/8"	Skin	20 u.	1,275 €
23101	1/2"	Skin	20 u.	1,386 €
23201	3/4"	Skin	20 u.	1,415 €
23301	1"	Skin	20 u.	1,455 €
32801	1 1/4"	Skin	20 u.	1,600 €
34101	1 1/2"	Skin	20 u.	1,500 €
23401	2"	Skin	20 u.	1,700 €



Juntas semicónicas blancas

Ref.	Medida	Embalaje	Uds.	Precio u.
8010	3/8"	Caja	25 u.	0,495 €
8011	1/2"	Caja	25 u.	0,539 €
8012	3/4"	Caja	25 u.	0,539 €
2390	1"	Caja	25 u.	0,539 €
3279	1" 1/4	Caja	25 u.	0,662 €
3760	1" 1/2	Caja	25 u.	0,625 €
2350	2"	Caja	25 u.	0,979 €



Juntas semicónicas blancas en Skin 3 uds.

Ref.	Medida	Embalaje	Uds.	Precio u.
80101	3/8"	Skin	20 u.	2,335 €
80111	1/2"	Skin	20 u.	2,467 €
80121	3/4"	Skin	20 u.	2,467 €
23901	1"	Skin	20 u.	2,467 €
32791	1" 1/4	Skin	20 u.	2,850 €
37601	1" 1/2	Skin	20 u.	2,750 €
23501	2"	Skin	20 u.	3,850 €



Sistema de fijación trasero que permite la unión de dos maletines con un simple movimiento

Maletín personalizable

Maletín de juntas EPDM 70°

· Total de 1196 juntas · Maletín con asidero

Ref.	Embalaje	Uds.	Precio u.
6625	Caja	1 u.	85,500 €





Junta flotador
20 uds.



3/8" Ancha
x 100 uds.



3/8" Estrecha
x 100 uds.



1/2" Ancha
x 75 uds.



1/2" Estrecha
x 100 uds.



3/4" Ancha
x 60 uds.



3/4" Estrecha
x 100 uds.



7/8"
x 30 uds.



1" Ancha
x 10 uds.



1" Estrecha
x 10 uds.



3/8" Ancha
x 100 uds.



3/8" Estrecha
x 100 uds.



1/2" Ancha
x 100 uds.



1/2" Estrecha
x 100 uds.



3/4" Ancha
x 30 uds.



3/4" Estrecha
x 40 uds.



1" Ancha
x 10 uds.



1" Estrecha
x 10 uds.



Semicónica 1 1/4"
x 7 uds.



Semicónica 1 1/2"
x 8 uds.



Blanca plana 1 1/4"
x 12 uds.



Blanca plana 1 1/2"
x 12 uds.



66 x 17 mm
Junta descarga
"Roca" x 6 uds.



66 x 32 mm
Junta descarga
"Roca" x 6 uds.



70 x 23 mm
Junta descarga
"Roca" x 6 uds.



Espumante 1518
x 3 uds.



Espumante 1519
x 2 uds.

Maletín de juntas multi instalaciones

· Total de 1122 juntas y 5 espumantes · Maletín con asidero

Ref.	Embalaje	Uds.	Precio u.
6850	Caja	1 u.	99,500 €



Sistema de fijación trasero que permite la unión de dos maletines con un simple movimiento

Maletín personalizable

Maletín de juntas multi instalaciones

· Total de 1186 juntas · Maletín con asidero

Ref.	Embalaje	Uds.	Precio u.
6650	Caja	1 u.	93,500 €



3/8" Ancha
x 200 uds.



3/8" Estrecha
x 200 uds.



1/2" Ancha
x 200 uds.



1/2" Estrecha
x 200 uds.



3/4" Ancha
x 90 uds.



3/4" Estrecha
x 100 uds.



1" Ancha
x 30 uds.



1" Estrecha
x 30 uds.



1" 1/4 Ancha
x 25 uds.



1" 1/4 Estrecha
x 25 uds.



1" 1/2 Ancha
x 16 uds.



1" 1/2 Estrecha
x 20 uds.



2" Ancha
x 10 uds.



3/4" + Filtro
x 10 uds.



1/2" + Filtro
x 30 uds.



Sistema de fijación trasero que permite la unión de dos maletines con un simple movimiento

Maletín personalizable

Maletín de juntas PTFE

· Total de 1141 juntas · Maletín con asidero

Ref.	Embalaje	Uds.	Precio u.
6675	Caja	1 u.	159,750 €





Poster Ahorro de Agua
DIN A1 - Ref. 20015



Poster Mango de ducha Colors
DIN A2 - Ref. 20035



Poster Aireador Universal
DIN A2 - Ref. 20010



Poster Grifería Industrial
DIN A1 - Ref. 20025
DIN A2 - Ref. 20030



Poster Flexo 9000
DIN A2 - Ref. 20040



Poster Mango de ducha Sun y Io
DIN A2 - Ref. 20045



Poster Válvula Porcelana
DIN A2 - Ref. 20050



Poster Aireadores Cocina
DIN A2 - Ref. 20055

Ref.	EAN 13	Página	P.V.P.
1010	8436040736678	37	192,850 €
1015	8436040737255	43	285,750 €
1017	8436040737361	43	285,750 €
1050	8436040738955	37	197,750 €
1100	8436040739655	44	85,750 €
1101	8436040731666	73	7,905 €
1110	8436040738962	43	304,900 €
1111	8436040731611	73	3,505 €
1112	8436040738979	44	96,250 €
1114	8436040731406	69	2,841 €
1116	8436040731413	69	2,841 €
1120	8436040737378	44	76,750 €
1122	8436040737545	43	304,900 €
1130	8436040739006	44	89,500 €
1140	8436040738931	44	92,500 €
1150	8436040739020	44	104,750 €
1154	8436040731369	69	3,595 €
1156	8436040731383	69	3,595 €
1164	8436040731420	68	10,911 €
1190	8436040739068	44	26,950 €
1192	8436040739075	44	39,750 €
1200	8436040739044	45	15,500 €
1210	8436040739051	45	14,255 €
1214	8436040731826	93	71,590 €
1215	8436040736777	93	27,166 €
1224	8436040731833	93	16,240 €
1234	8436040731918	92	12,877 €
1235	8436040731925	92	12,877 €
1244	8436040731857	92	11,750 €
1250	8436040737170	39	295,250 €
1255	8436040739136	39	295,250 €
1260	8436040737163	39	313,500 €
1265	8436040736883	39	313,500 €
1270	8436040739105	41	275,500 €
1275	8436040736944	41	275,500 €
1280	8436040739099	41	295,750 €
1285	8436040736968	41	295,750 €
1314	8436040733547	170	27,995 €
1318	8436040733554	170	27,995 €
1321	8436040737934	77	21,975 €
1322	8436040737941	77	21,975 €
1323	8436040737958	77	21,975 €
1408	8436040736708	77	12,502 €
1413	8436040731192	76	9,433 €
1414	8436040731215	76	11,892 €
1421	8436040731185	76	12,381 €
1511	8436040732991	149	1,532 €
1512	8436040733004	149	1,532 €
1515	8436040733028	150	3,195 €
1516	8436040733042	150	4,750 €
1517	8436040733059	150	4,750 €
1518	8436040732977	149	2,450 €
1519	8436040732984	149	2,450 €
1521	8436040730218	149	1,167 €
1522	8436040733011	149	1,167 €
1525	8436040737316	150	1,105 €

Ref.	EAN 13	Página	P.V.P.
1530	8436040737323	150	1,105 €
1912	8436040730690	51	1,295 €
2030	8436040738863	176	0,519 €
2050	8436040738801	176	0,049 €
2060	8436040738818	176	0,079 €
2070	8436040738825	176	0,109 €
2080	8436040738832	176	0,159 €
2085	8436040732694	176	0,205 €
2090	8436040738849	176	0,309 €
2100	8436040738924	176	0,379 €
2110	8436040738870	176	0,049 €
2111	8436040731642	69	3,945 €
2112	8436040731659	69	0,955 €
2113	8436040731635	69	6,595 €
2120	8436040738887	176	0,069 €
2130	8436040738894	176	0,099 €
2140	8436040738900	176	0,149 €
2150	8436040738917	176	0,309 €
2160	8436040738856	176	0,379 €
2170	8436040738696	177	0,128 €
2180	8436040738702	177	0,153 €
2190	8436040738719	177	0,193 €
2200	8436040738726	177	0,207 €
2230	8436040738764	177	0,132 €
2240	8436040738771	177	0,149 €
2250	8436040738788	177	0,169 €
2260	8436040738795	177	0,226 €
2270	8436040738733	177	0,335 €
2280	8436040738740	177	0,355 €
2290	8436040738757	177	0,578 €
2300	8436040734261	179	0,128 €
2310	8436040734278	179	0,149 €
2311	8436040731529	70	4,416 €
2313	8436040734421	71	18,312 €
2320	8436040734285	179	0,176 €
2324	8436040731468	70	5,105 €
2328	8436040731475	70	4,190 €
2330	8436040734292	179	0,188 €
2332	8436040735923	125	4,250 €
2334	8436040731505	70,81	2,726 €
2336	8436040731512	70	2,546 €
2340	8436040734308	179	0,236 €
2350	8436040734315	179	0,979 €
2390	8436040738689	179	0,539 €
2410	8436040731550	81	35,500 €
2411	8436040737613	50	3,945 €
2412	8436040737620	50	3,945 €
2413	8436040737637	50	3,945 €
2415	8436040735893	125	42,500 €
2420	8436040731574	81	11,750 €
2445	8436040735909	125	26,500 €
2450	8436040737187	80	66,500 €
2511	8436040731727	86	4,532 €
2512	8436040731734	86	5,387 €
2550	8436040739570	87	3,055 €
2575	8436040739563	87	1,509 €

Ref.	EAN 13	Página	P.V.P.	Ref.	Código EAN 13	Página	P.V.P.
2600	8436040734186	178	0,579 €	3155	8436040733448	165	3,040 €
2611	8436040730461	50	2,823 €	3156	8436040733417	165	2,265 €
2612	8436040730478	50	2,823 €	3157	8436040733424	165	3,040 €
2625	8436040734193	178	0,579 €	3168	8436040733745	171	10,352 €
2811	8436040733288	166	4,650 €	3181	8436040730201	52	2,429 €
2821	8436040733264	161	0,738 €	3194	8436040734070	175	0,167 €
2960	8436040732724	136	22,250 €	3195	8436040734087	175	0,175 €
2970	8436040732717	136	22,250 €	3196	8436040733455	164	0,621 €
2980	8436040732700	135	24,975 €	3197	8436040730072	88	17,401 €
2990	8436040732663	134	15,975 €	3198	8436040733387	175	0,235 €
3000	8436040732625	134	11,250 €	3200	8436040736715	68	11,250 €
3001	8436040732564	134	14,605 €	3201	8436040736722	70	7,250 €
3002	8436040732502	134	20,995 €	3202	8436040736814	171	1,955 €
3003	8436040732526	134	20,995 €	3203	8436040730362	35	45,880 €
3004	8436040733127	152	2,185 €	3225	8436040737552	35	2,755 €
3007	8436040732588	135	23,570 €	3240	8436040738641	178	0,330 €
3008	8436040732540	134	14,605 €	3266	8436040733271	161	1,295 €
3009	8436040732687	135	21,500 €	3277	8436040733486	161	0,179 €
3010	8436040732168	128	13,970 €	3279	8436040733462	161,179	0,662 €
3011	8436040730164	129	28,810 €	3280	8436040733479	161,179	0,189 €
3012	8436040732137	129	26,320 €	3281	8436040734148	175	0,167 €
3013	8436040738320	128	16,994 €	3287	8436040733332	163	1,258 €
3014	8436040732205	128	18,156 €	3289	8436040730614	53	1,235 €
3015	8436040730652	51	0,691 €	3290	8436040730607	53	1,235 €
3016	8436040732182	128	13,970 €	3292	8436040730836	8	14,250 €
3019	8436040732854	140	3,105 €	3297	8436040731079	34	28,950 €
3023	8436040732090	128	16,994 €	3310	8436040736487	26	108,570 €
3029	8436040732908	142	0,415 €	3311	8436040736470	26	67,500 €
3030	8436040730065	141	11,950 €	3312	8436040736463	26	67,500 €
3033	8436040732830	140	1,605 €	3313	8436040730133	20	14,500 €
3034	8436040732878	141	0,215 €	3314	8436040730140	21	14,750 €
3040	8436040732649	134	11,250 €	3315	8436040738344	158	26,315 €
3097	8436040734483	88	17,401 €	3317	8436040730485	50	2,823 €
3100	8436040731628	73	0,819 €	3350	8436040730294	20	16,950 €
3102	8436040731604	73	2,975 €	3360	8436040736135	21	17,500 €
3103	8436040730522	52	2,295 €	3380	8436040732861	141	4,950 €
3104	8436040730188	52	2,295 €	3390	8436040733318	162	3,550 €
3105	8436040730171	52	2,295 €	3393	8436040734476	166	0,772 €
3106	8436040730195	52	2,295 €	3402	8436040730546	48	11,500 €
3107	8436040730577	52	2,839 €	3403	8436040730560	49	10,505 €
3108	8436040730584	52	2,839 €	3405	8436040739204	48	13,950 €
3109	8436040730591	52	2,839 €	3408	8436040733868	48	12,250 €
3110	8436040736845	52	2,839 €	3409	8436040733257	163	0,357 €
3123	8436040733165	159	16,500 €	3410	8436040734209	179	0,207 €
3124	8436040733172	159	18,900 €	3411	8436040737224	49	0,757 €
3125	8436040733189	160	16,750 €	3412	8436040736548	49	0,859 €
3126	8436040733394	166	5,088 €	3418	8436040732601	135	23,450 €
3127	8436040733400	166	3,872 €	3429	8436040733295	162	2,542 €
3139	8436040733196	160	4,695 €	3447	8436040734018	170	0,876 €
3140	8436040733202	160	5,535 €	3468	8436040734056	175	0,059 €
3144	8436040733240	160	3,410 €	3489	8436040733707	171	8,652 €
3147	8436040733349	164	2,047 €	3490	8436040733653	171	8,652 €
3148	8436040733370	164	3,616 €	3491	8436040733530	167	0,545 €
3151	8436040733356	164	3,911 €	3494	8436040732229	130	24,905 €
3152	8436040733363	164	3,911 €	3497	8436040731697	89	3,198 €
3154	8436040733431	165	2,265 €	3499	8436040734032	175	0,051 €

Ref.	EAN 13	Página	P.V.P.	Ref.	EAN 13	Página	P.V.P.
3517	8436040730553	49	7,910 €	4015	8436040734131	175	0,086 €
3519	8436040738047	86	3,712 €	4016	8436040734063	175	0,088 €
3522	8436040731239	76	8,355 €	4035	8436040736098	14	43,500 €
3540	8436040730638	49	3,890 €	4038	8436040733509	167	0,495 €
3594	8436040738191	115,130	49,500 €	4045	8436040734254	178	0,213 €
3596	8436040735558	113	57,500 €	4047	8436040730126	53	9,751 €
3597	8436040731703	89	3,198 €	4050	8436040734643	10	29,500 €
3615	8436040733691	171	8,652 €	4055	8436040736111	13	43,500 €
3621	8436040731161	31	1,495 €	4070	8436040736128	14	43,500 €
3625	8436040731765	87	3,339 €	4090	8436040736197	12	43,750 €
3627	8436040734025	170	0,876 €	4100	8436040730102	30	19,850 €
3630	8436040737880	72	21,965 €	4110	8436040730287	30	19,250 €
3632	8436040731680	73	18,500 €	4120	8436040737477	13	43,500 €
3633	8436040733035	150	1,812 €	4125	8436040737491	13	27,500 €
3645	8436040737873	72	25,751 €	4130	8436040738153	14	43,500 €
3649	8436040734049	175	0,051 €	4140	8436040737453	14	43,500 €
3650	8436040734117	175	0,051 €	4145	8436040737460	14	27,500 €
3651	8436040734124	175	0,059 €	4150	8436040737415	31	19,250 €
3652	8436040738627	175	0,062 €	4155	8436040737521	31	18,250 €
3654	8436040739631	97	0,245 €	4181	8436040737125	136	2,595 €
3674	8436040731321	69	2,975 €	4200	8436040730119	31	16,702 €
3675	8436040731345	69	2,975 €	4250	8436040738252	115,136	3,050 €
3680	8436040731017	29	6,755 €	4282	8436040734865	115	3,980 €
3694	8436040731673	73	10,900 €	4300	8436040736562	11	23,509 €
3697	8436040731710	89	8,815 €	4350	8436040736586	11	12,325 €
3729	8436040732250	131	25,065 €	4400	8436040730881	11	46,602 €
3731	8436040731154	31	1,495 €	4450	8436040730904	11	27,847 €
3732	8436040733301	162	1,795 €	4500	8436040730867	11	27,750 €
3734	8436040734247	178	0,213 €	4501	8436040736371	13	22,650 €
3739	8436040732267	131	25,065 €	4504	8436040736395	12	28,500 €
3760	8436040734216	179	0,625 €	4506	8436040736326	12	21,950 €
3779	8436040730645	51	1,395 €	4507	8436040736319	13	21,950 €
3783	8436040730744	48	9,505 €	4508	8436040736340	13	27,500 €
3792	8436040733585	171	1,056 €	4509	8436040736333	14	27,500 €
3793	8436040733592	171	1,414 €	4510	8436040736364	12	21,950 €
3794	8436040733608	171	1,662 €	4510	8436040737507	14	27,500 €
3797	8436040739624	89	18,270 €	4511	8436040736357	14	27,500 €
3807	8436040733752	171	10,352 €	4512	8436040736166	13	47,500 €
3808	8436040733738	171	10,352 €	4513	8436040736173	13	43,750 €
3810	8436040730508	50	2,535 €	4514	8436040736180	12	55,750 €
3815	8436040738030	86	6,201 €	4515	8436040736203	12	43,750 €
3916	8436040730621	49	3,890 €	4534	8436040731772	87	4,012 €
3920	8436040730669	51	0,735 €	4535	8436040738085	87	4,755 €
3922	8436040730676	51	0,855 €	4536	8436040738092	87	6,104 €
3930	8436040731987	97	96,500 €	4550	8436040730911	11	15,250 €
3950	8436040737606	49	3,890 €	4599	8436040736890	19	6,500 €
3960	8436040731222	76	6,695 €	4600	8436040730874	11	46,602 €
3968	8436040731338	69	7,779 €	4650	8436040730928	11	24,344 €
3969	8436040731352	69	7,779 €	4660	8436040730348	87	4,886 €
3970	8436040733066	150	4,950 €	4756	8436040733325	162	2,835 €
3975	8436040732045	150	6,250 €	4789	8436040731260	78	18,905 €
3984	8436040736838	97	6,750 €	4800	8436040730843	9	23,950 €
3985	8436040734988	97	7,950 €	4811	8436040732915	142	0,395 €
3994	8436040738214	130	39,500 €	4827	8436040736746	72	9,950 €
3996	8436040731208	76	10,889 €	4829	8436040739488	72	12,500 €
4000	8436040736159	10	39,750 €	4894	8436040733622	171	8,652 €

Ref.	EAN 13	Página	P.V.P.	Ref.	Código EAN 13	Página	P.V.P.
5000	8436040732762	133	2,950 €	6515	8436040735176	114	26,500 €
5100	8436040732274	131	21,950 €	6520	8436040735091	114	22,500 €
5110	8436040732298	131	21,950 €	6525	8436040735084	101	239,750 €
5200	8436040732311	131	15,505 €	6530	8436040735046	100	332,250 €
5210	8436040732335	131	15,505 €	6531	8436040731970	104	198,250 €
5250	8436040732359	132	24,970 €	6535	8436040735060	100	297,750 €
5300	8436040732373	132	24,850 €	6540	8436040735077	101	247,950 €
5320	8436040733615	171	8,652 €	6545	8436040735053	100	306,750 €
5400	8436040732397	132	12,150 €	6555	8436040735039	100	340,750 €
5410	8436040732410	132	12,150 €	6560	8436040735206	103	308,250 €
5437	8436040731543	71	6,815 €	6565	8436040735213	103	276,500 €
5439	8436040736739	71	14,545 €	6600	8436040737033	174	3,950 €
5445	8436040734766	71	33,900 €	6625	8436040730225	180	85,500 €
5459	8436040732885	141	0,215 €	6631	8436040732007	116	36,570 €
5500	8436040732434	132	16,875 €	6644	8436040733516	167	0,422 €
5559	8436040737347	143	2,704 €	6650	8436040730256	182	93,500 €
5575	8436040737354	143	1,945 €	6675	8436040730249	182	159,750 €
5600	8436040732458	133	22,995 €	6700	8436040735350	108	135,500 €
5700	8436040732472	133	25,863 €	6705	8436040735367	108	110,500 €
5800	8436040732489	133	23,150 €	6708	8436040735022	109	88,750 €
5900	8436040732496	133	23,150 €	6710	8436040734780	108	167,500 €
5987	8436040733646	171	8,652 €	6715	8436040734797	108	142,500 €
6000	8436040736005	33	33,900 €	6720	8436040735497	111	195,850 €
6025	8436040733998	33	29,900 €	6725	8436040730263	112	171,250 €
6050	8436040734827	33	30,900 €	6730	8436040735503	111	218,750 €
6062	8436040733769	171	10,352 €	6731	8436040732014	117	28,390 €
6075	8436040730812	33	36,900 €	6732	8436040734896	117	39,750 €
6081	8436040732892	142	1,559 €	6735	8436040734803	112	193,650 €
6085	8436040739181	33	35,900 €	6740	8436040735398	109	68,250 €
6095	8436040734452	33	32,900 €	6742	8436040735381	109	76,250 €
6100	8436040731031	29	3,495 €	6745	8436040735374	109	51,250 €
6138	8436040733776	171	10,352 €	6747	8436040735404	109	59,250 €
6143	8436040733677	171	8,652 €	6755	8436040735428	110	29,250 €
6172	8436040737897	73	7,950 €	6757	8436040735411	110	37,250 €
6192	8436040734155	175	0,199 €	6760	8436040735480	111	41,500 €
6200	8436040732151	111	72,150 €	6762	8436040735435	110	90,500 €
6205	8436040732144	111	64,150 €	6763	8436040735442	110	82,500 €
6311	8436040733233	160	1,357 €	6765	8436040735466	110	63,500 €
6339	8436040731994	97	48,710 €	6767	8436040735459	110	71,500 €
6400	8436040735800	120	145,000 €	6772	8436040735473	111	49,500 €
6405	8436040735817	121	129,250 €	6780	8436040735527	112	90,500 €
6410	8436040735824	121	113,750 €	6782	8436040735510	112	98,500 €
6415	8436040735831	120	199,500 €	6785	8436040735541	112	71,500 €
6420	8436040735848	121	185,250 €	6787	8436040735534	112	79,500 €
6425	8436040735855	121	171,250 €	6788	8436040738177	113	97,750 €
6429	8436040732793	136	2,105 €	6789	8436040735930	113	89,750 €
6430	8436040735862	120	203,750 €	6790	8436040732304	117	28,390 €
6431	8436040731932	98	285,250 €	6795	8436040732175	110	59,500 €
6435	8436040735008	98	319,500 €	6797	8436040732199	110	51,900 €
6440	8436040735879	121	188,500 €	6805	8436040735268	106	354,250 €
6442	8436040733639	171	8,652 €	6809	8436040731956	106	319,750 €
6445	8436040735886	121	173,500 €	6810	8436040738160	150	6,250 €
6450	8436040732328	120	129,250 €	6815	8436040733073	150	4,950 €
6460	8436040732403	120	188,500 €	6819	8436040732021	114	39,500 €
6470	8436040732342	120	185,250 €	6820	8436040738139	114	26,500 €
6500	8436040737040	174	3,950 €	6824	8436040732038	128	24,650 €

Ref.	EAN 13	Página	P.V.P.
6831	8436040738108	122	95,100 €
6834	8436040732052	128	24,650 €
6835	8436040732069	109	125,500 €
6839	8436040731116	35	51,520 €
6840	8436040731147	35	21,505 €
6850	8436040730235	181	99,500 €
6851	8436040732731	131	5,105 €
6852	8436040738115	122	152,500 €
6854	8436040738122	122	155,250 €
6855	8436040735107	114	6,250 €
6858	8436040738472	122	62,400 €
6859	8436040734759	122	3,740 €
6860	8436040734940	115	4,900 €
6865	8436040737385	123	24,500 €
6866	8436040735787	123	26,500 €
6870	8436040734933	115,118	9,500 €
6875	8436040735947	115	3,250 €
6880	8436040735114	115	8,750 €
6882	8436040735220	114	16,750 €
6886	8436040735343	114	39,500 €
6890	8436040734926	115	4,800 €
6895	8436040735633	118	7,500 €
6900	8436040735664	119	294,000 €
6903	8436040731253	78	19,867 €
6905	8436040731246	78	18,741 €
6909	8436040736692	78	21,852 €
6910	8436040735671	119	56,570 €
6915	8436040735695	119	16,800 €
6920	8436040735701	119	16,800 €
6925	8436040735718	119	8,750 €
6930	8436040735732	119	5,960 €
6931	8436040736784	115	28,500 €
6932	8436040734919	116	33,750 €
6935	8436040735725	119	5,750 €
6940	8436040735602	118	225,000 €
6942	8436040735619	118	235,000 €
6945	8436040735626	118	12,790 €
6950	8436040735640	118	8,250 €
6955	8436040735657	118	23,750 €
6958	8436040732427	123	38,250 €
6959	8436040732441	123	40,250 €
6960	8436040735794	122	18,750 €
6965	8436040735749	123	57,500 €
6966	8436040735756	123	59,500 €
6970	8436040735763	123	38,250 €
6971	8436040733110	151	12,950 €
6975	8436040735770	123	40,250 €
6994	8436040730683	51	1,075 €
7004	8436040730713	51	0,100 €
7005	8436040730706	51	0,085 €
7010	8436040736241	148	13,950 €
7015	8436040736272	149	9,950 €
7020	8436040737286	155	4,350 €
7025	8436040730058	148	10,500 €
7030	8436040730096	149	4,250 €
7045	8436040737293	155	4,750 €

Ref.	EAN 13	Página	P.V.P.
7050	8436040734957	116	38,750 €
7055	8436040734964	116	6,650 €
7060	8436040734858	116	92,500 €
7062	8436040735596	116	11,750 €
7065	8436040735565	116	4,500 €
7075	8436040734902	116	21,750 €
7080	8436040735572	116	0,420 €
7082	8436040735589	116	0,420 €
7133	8436040730089	8	10,750 €
7274	8436040738351	158	28,500 €
7275	8436040732939	159	31,500 €
7276	8436040737330	143	3,596 €
7300	8436040733134	151	13,500 €
7400	8436040730751	53	6,820 €
7444	8436040734346	8	5,950 €
7476	8436040738269	143	3,521 €
7500	8436040730768	53	3,838 €
7555	8436040736234	8	5,550 €
7576	8436040732922	142	1,565 €
7596	8436040730997	29	4,926 €
7600	8436040730775	53	3,838 €
7611	8436040731307	68	8,250 €
7615	8436040736555	63	10,750 €
7672	8436040733660	171	8,652 €
7674	8436040733714	171	10,352 €
7675	8436040733721	171	10,352 €
7677	8436040733790	171	10,352 €
7678	8436040733806	171	10,352 €
7690	8436040734377	56	24,750 €
7692	8436040737866	72	18,560 €
7693	8436040736753	72	22,360 €
7700	8436040730027	147	5,950 €
7776	8436040731048	28	2,150 €
7790	8436040731055	28	6,250 €
7800	8436040730010	147	5,950 €
7812	8436040731024	29	7,767 €
7900	8436040732076	154	4,850 €
7915	8436040730034	50	10,985 €
7916	8436040730041	50	10,985 €
7925	8436040732120	154	4,850 €
7950	8436040737262	154	4,450 €
7954	8436040730942	19	5,955 €
7964	8436040730959	19	5,955 €
7970	8436040737309	155	2,230 €
7975	8436040737279	154	4,900 €
8000	8436040730973	23	69,500 €
8010	8436040738658	179	0,495 €
8011	8436040738665	179	0,539 €
8012	8436040738672	179	0,539 €
8015	8436040737576	27	195,750 €
8020	8436040734360	19	23,865 €
8023	8436040730447	34	19,664 €
8025	8436040730980	23	82,500 €
8026	8436040736449	25	159,750 €
8027	8436040730324	27	195,750 €
8075	8436040738283	117,137	9,450 €

Ref.	EAN 13	Página	P.V.P.	Ref.	Código EAN 13	Página	P.V.P.
8080	8436040732281	117	28,390 €	8615	8436040730423	34	26,500 €
8085	8436040738290	117,137	9,470 €	8650	8436040730157	21	14,750 €
8120	8436040732243	130	28,970 €	8660	8436040739167	21	17,500 €
8150	8436040737026	20	36,650 €	8671	8436040734094	175	0,226 €
8155	8436040737446	20	39,500 €	8675	8436040738535	175	0,495 €
8173	8436040734100	175	0,051 €	8700	8436040731871	93	18,085 €
8200	8436040732946	148	5,950 €	8701	8436040731888	93	18,685 €
8287	8436040738054	86	7,164 €	8750	8436040730492	51	10,985 €
8288	8436040739556	77	17,502 €	8760	8436040730720	9	7,500 €
8289	8436040736685	77	20,752 €	8765	8436040730737	9	5,845 €
8300	8436040736456	24	150,000 €	8775	8436040731802	92	99,950 €
8305	8436040735251	106	449,500 €	8800	8436040731123	35	16,250 €
8310	8436040734841	98	430,500 €	8801	8436040731130	35	17,500 €
8311	8436040731963	106	415,500 €	8810	8436040731291	68	11,900 €
8312	8436040735244	106	449,500 €	8825	8436040735275	114	125,500 €
8313	8436040731949	98	364,150 €	8840	8436040731376	69	7,290 €
8314	8436040735237	106	484,250 €	8841	8436040731390	69	7,290 €
8315	8436040734834	98	398,500 €	8850	8436040733950	61	22,250 €
8320	8436040737590	27	240,000 €	8870	8436040731895	92	7,950 €
8325	8436040735299	104	415,250 €	8875	8436040733967	61	18,500 €
8328	8436040734162	175	0,226 €	8900	8436040733523	167	0,495 €
8330	8436040734995	98	396,250 €	9000	8436040731178	74	18,750 €
8340	8436040735312	105	385,750 €	9016	8436040737903	74,81	15,950 €
8345	8436040735282	104	449,750 €	9024	8436040735916	125	16,750 €
8350	8436040731093	28	6,857 €	9025	8436040733912	58	42,950 €
8355	8436040735015	114	71,750 €	9030	8436040733080	152	4,550 €
8360	8436040735305	105	399,750 €	9035	8436040733097	152	4,550 €
8365	8436040737569	28	3,750 €	9040	8436040733103	152	4,550 €
8370	8436040736531	50	10,985 €	9050	8436040733929	58	36,500 €
8375	8436040737194	28	1,902 €	9080	8436040734179	175	0,115 €
8380	8436040735336	105	290,500 €	9200	8436040730799	163	2,075 €
8385	8436040735329	105	299,750 €	9300	8436040730782	163	4,457 €
8390	8436040735121	101	384,950 €	9400	8436040736807	163	4,195 €
8392	8436040735138	101	369,750 €	9500	8436040736951	147	6,500 €
8394	8436040735145	102	347,500 €	9600	8436040739389	62	23,900 €
8396	8436040735152	102	335,250 €	9800	8436040736661	63	16,500 €
8397	8436040734810	102	289,500 €	9825	8436040737156	56	18,500 €
8398	8436040735169	102	275,250 €	9850	8436040737149	62	19,900 €
8400	8436040736258	22	310,000 €	9875	8436040733936	60	37,750 €
8410	8436040736579	12	189,571 €	9880	8436040739365	59	42,500 €
8412	8436040738146	12	52,607 €	9890	8436040733943	60	26,950 €
8413	8436040737422	16	319,500 €	9895	8436040739372	59	31,250 €
8414	8436040737408	15	360,462 €	9900	8436040732953	148	8,500 €
8415	8436040737057	27	550,000 €	9925	8436040737132	57	3,000 €
8416	8436040737514	15	519,900 €	9950	8436040732960	148	1,705 €
8425	8436040733493	16	475,000 €	10152	8436040736982	43	310,500 €
8430	8436040733684	17	392,230 €	10172	8436040737002	43	310,500 €
8450	8436040731062	28	7,582 €	11011	8436040739549	73	8,505 €
8475	8436040736265	28	8,623 €	11102	8436040736999	43	339,900 €
8490	8436040731277	78	22,989 €	11111	8436040739518	73	4,105 €
8500	8436040731314	68	7,825 €	11222	8436040737019	43	339,900 €
8550	8436040730966	22	62,500 €	12241	8436040731840	93	16,840 €
8551	8436040736432	25	139,500 €	12441	8436040731864	92	12,350 €
8552	8436040736425	24	165,500 €	12502	8436040737064	39	320,500 €
8559	8436040737583	27	155,000 €	12552	8436040737095	39	320,500 €
8600	8436040730430	34	22,255 €	12602	8436040736227	39	338,500 €

Ref.	EAN 13	Página	P.V.P.
12652	8436040739112	39	338,500 €
12702	8436040739129	41	299,750 €
12752	8436040739082	41	299,750 €
12802	8436040739150	41	322,750 €
12852	8436040736975	41	322,750 €
14212	8436040736654	76	7,297 €
20010		186	
20015		184	
20025		184	
20030		184	
20035		185	
20040		185	
20045		186	
20050		186	
20055		186	
20301	8436040730515	176	5,965 €
20501	8436040730379	176	1,188 €
20601	8436040730386	176	1,248 €
20701	8436040730393	176	1,582 €
20801	8436040730409	176	1,828 €
20851	8436040732618	176	4,950 €
20901	8436040730416	176	3,551 €
21001	8436040731000	176	4,359 €
21101	8436040730539	176	1,248 €
21201	8436040730805	176	1,318 €
21301	8436040730829	176	1,582 €
21401	8436040730898	176	2,209 €
21501	8436040730935	176	3,551 €
21601	8436040730454	176	4,359 €
21701	8436040731109	177	1,695 €
21801	8436040731437	177	1,918 €
21901	8436040731444	177	2,345 €
22001	8436040731451	177	2,545 €
22301	8436040732113	177	1,695 €
22401	8436040732236	177	1,918 €
22501	8436040733141	177	2,345 €
22601	8436040733158	177	2,545 €
22701	8436040731598	177	3,405 €
22801	8436040731819	177	3,550 €
22901	8436040732106	177	5,198 €
23001	8436040736067	179	1,275 €
23101	8436040739648	179	1,386 €
23111	8436040731536	70	5,031 €
23131	8436040734438	71	18,912 €
23201	8436040736074	179	1,415 €
23241	8436040731482	70	5,705 €
23281	8436040731499	70	4,823 €
23301	8436040736104	179	1,455 €
23341	8436040734407	70	3,326 €
23361	8436040739419	70	3,146 €
23401	8436040736289	179	1,700 €
23501	8436040736517	179	3,850 €
23901	8436040736418	179	2,467 €
25111	8436040731741	86	5,245 €
25121	8436040731758	86	6,166 €
26001	8436040736043	178	2,850 €

Ref.	EAN 13	Página	P.V.P.
26251	8436040736050	178	2,850 €
30131	8436040732083	128	17,694 €
30141	8436040738184	128	18,856 €
30231	8436040739198	128	17,694 €
30301	8436040738313	141	12,550 €
30971	8436040739587	88	18,092 €
31021	8436040739501	73	3,575 €
31031	8436040737644	52	2,795 €
31032	8436040739242	52	3,120 €
31041	8436040737651	52	2,795 €
31042	8436040739259	52	3,120 €
31051	8436040737668	52	2,795 €
31052	8436040739266	52	3,120 €
31061	8436040737675	52	2,795 €
31062	8436040739273	52	3,120 €
31071	8436040737699	52	3,315 €
31072	8436040739297	52	3,695 €
31081	8436040737705	52	3,315 €
31082	8436040739303	52	3,695 €
31091	8436040737712	52	3,315 €
31092	8436040739310	52	3,695 €
31101	8436040737729	52	3,315 €
31102	8436040739327	52	3,743 €
31242	8436040736791	160	0,825 €
31471	8436040732519	164	2,647 €
31481	8436040732366	164	4,216 €
31511	8436040732380	164	4,511 €
31521	8436040732465	164	4,511 €
31541	8436040732557	165	2,765 €
31551	8436040732632	165	3,540 €
31561	8436040732571	165	2,765 €
31571	8436040732656	165	3,540 €
31811	8436040737682	52	2,852 €
31812	8436040739280	52	3,205 €
31941	8436040738498	175	1,950 €
31951	8436040738504	175	2,150 €
31961	8436040732533	164	1,021 €
31971	8436040739594	88	18,092 €
31981	8436040733882	175	2,975 €
32031	8436040730331	35	47,120 €
32401	8436040734674	178	1,895 €
32791	8436040736494	179	2,850 €
32801	8436040736210	179	1,600 €
32811	8436040738597	175	1,950 €
32891	8436040739341	53	1,635 €
32901	8436040739358	53	1,635 €
33292	8436040736081	18	0,846 €
33801	8436040738306	141	5,550 €
33901	8436040738382	162	4,150 €
33931	8436040737248	166	2,995 €
34021	8436040733851	48	12,100 €
34031	8436040739235	49	11,105 €
34051	8436040739228	48	14,550 €
34081	8436040739211	48	12,850 €
34101	8436040734704	179	1,500 €
34291	8436040738375	162	2,995 €

Ref.	EAN 13	Página	P.V.P.	Ref.	Código EAN 13	Página	P.V.P.
34471	8436040732595	117	170	60851	8436040735978	33	36,900 €
34681	8436040738474	117,137	175	60951	8436040738436	33	33,900 €
34911	8436040736524	130	167	61921	8436040738603	175	2,235 €
34941	8436040732212	20	130	64291	8436040732809	136	0,995 €
34942	8436040738238	20	130	64292	8436040732816	136	0,995 €
34971	8436040739600	175	89	66441	8436040737231	167	2,300 €
34991	8436040738450	148	175	68511	8436040732748	131	1,250 €
35171	8436040739662	86	49	68512	8436040732755	131	1,250 €
35191	8436040737071	77	86	69031	8436040737965	78	5,250 €
35401	8436040735992	77	49	71331	8436040737392	8	11,350 €
35942	8436040738207	24	130	74001	8436040737750	53	7,420 €
35971	8436040739617	106	89	74441	8436040733561	8	6,550 €
36251	8436040731789	98	87	75001	8436040737736	53	4,438 €
36271	8436040732670	106	170	75551	8436040737439	8	6,150 €
36301	8436040739471	106	72	75961	8436040738368	29	5,526 €
36321	8436040739525	98	73	76001	8436040737743	53	4,438 €
36451	8436040739464	106	72	76921	8436040739457	72	19,060 €
36491	8436040738467	98	175	76931	8436040739440	72	22,960 €
36501	8436040738559	27	175	77002	8436040736913	153	0,250 €
36511	8436040738566	104	175	78002	8436040736906	153	0,250 €
36521	8436040738573	175	175	78121	8436040736142	29	8,362 €
36941	8436040739532	98	73	80101	8436040736291	179	2,335 €
37321	8436040738405	105	162	80111	8436040736302	179	2,467 €
37341	8436040734650	104	178	80121	8436040736401	179	2,467 €
37601	8436040736500	28	179	81202	8436040738245	130	30,970 €
37831	8436040735961	114	48	81731	8436040738542	175	0,952 €
38151	8436040737088	105	86	82871	8436040737118	86	8,234 €
39161	8436040736012	28	49	83281	8436040738610	175	2,500 €
39501	8436040735958	50	49	83651	8436040733837	28	4,350 €
39942	8436040738221	28	130	86711	8436040738511	175	2,520 €
40151	8436040738580	105	175	86751	8436040738528	175	5,101 €
40161	8436040738481	105	175	88701	8436040731901	92	8,550 €
40381	8436040734223	101	167	89001	8436040736821	167	2,350 €
40451	8436040734667	101	178	90801	8436040730317	175	1,395 €
40471	8436040739334	102	53	93001	8436040738429	163	4,955 €
41101	8436040739174	102	31	94001	8436040738412	163	4,695 €
41811	8436040738276	102	115,136	100100	8436040737927	75	237,450 €
45341	8436040731796	102	87	100125	8436040731567	82	332,500 €
45351	8436040738061	22	87	100150	8436040737972	82	475,500 €
45361	8436040738078	12	87	100175	8436040731581	82	260,850 €
45501	8436040736593	12	18	100200	8436040737989	82	405,850 €
45502	8436040736609	16	18	100225	8436040737996	83	365,000 €
45503	8436040736616	15	18	100250	8436040738009	83	510,000 €
45504	8436040736623	27	18	100275	8436040738016	83	241,500 €
45761	8436040738399	15	162	100300	8436040738023	83	444,500 €
48271	8436040734629	16	72	100325	8436040737774	64	385,000 €
48291	8436040739495	17	72	100400	8436040737798	66	102,500 €
50001	8436040732779	28	133	100500	8436040737811	66	159,000 €
50002	8436040732786	28	133	100500	8436040738443	146	141,840 €
54371	8436040736760	78	71	100575	8436040739396	65	389,200 €
54391	8436040739426	68	71	100600	8436040737804	66	130,750 €
54451	8436040739433	22	71	100725	8436040739402	65	326,000 €
60002	8436040731086	25	32	100800	8436040737828	64	440,850 €
60251	8436040730270	24	33	100825	8436040737767	75	249,900 €
60501	8436040736036	27	33	100875	8436040737781	64	265,500 €
60751	8436040730850	34	33	100900	8436040737835	64	480,000 €

Ref.	EAN 13	Página	P.V.P.
100950	8436040737859	65	336,700 €
100975	8436040737910	75	237,450 €
103100	8436040734230	65	202,500 €
103200	8436040734339	66	99,000 €
151502	8436040736920	153	0,250 €
410001	8436040736630	31	6,950 €
410002	8436040737200	31	1,750 €
420001	8436040737217	31	1,650 €
420002	8436040736647	31	4,255 €
820002	8436040736937	153	0,250 €

Condiciones generales de venta

General

Las ventas y/o suministros entregados por Ducha-Flex, SCP se regirán por las presentes Condiciones Generales de Venta, a no ser que esté expresamente acordado de forma diferente en la oferta correspondiente o en la aceptación del pedido y que además constituya las condiciones particulares del mismo. Por ello no tendrán ningún tipo de valor ni efecto jurídico otras condiciones que no se hayan aceptado explícitamente por nuestra parte.

Precios y portes

Los precios indicados en este catálogo están expresados en €. Consideramos aceptables pedidos mínimos de 30€ netos y se concederán a portes pagados los superiores a 250€ netos dentro de la península, para Baleares, 490€ netos y para Ceuta, Melilla e islas Canarias 1500€ netos.

Nos reservamos el derecho de modificar los precios de la tarifa en vigor en cualquier momento sin necesidad de previo aviso por circunstancias del mercado.

Condiciones de pago

Las financiaciones máximas serán de 60 días, y el porcentaje de descuento por pronto pago no excederá del 1%. El interés de demora por financiación y por aplazamiento de los pagos de facturas pendientes será de un 1% mensual.

Reserva de dominio

El proveedor conserva la propiedad de la mercancía, hasta que todas las deudas, incluidos los intereses existentes, entre proveedor y cliente hayan sido satisfechas completamente.

Devoluciones de material

No se aceptará ninguna devolución del material sin el consentimiento por escrito de Duchaflex.

En el caso de aceptación de una devolución de mercancía, todos los gastos que ello signifiquen incluidos los portes del transporte irán a cargo del cliente y serán gestionados por una agencia de transporte de Duchaflex.

Los abonos por devoluciones de material no defectuoso se estudiarán en base a los criterios estipulados por Duchaflex y en el caso de que sean aceptadas por escrito por Duchaflex se aplicará un demérito por manipulación y de recepción en base a los siguientes parámetros:

- a) Hasta 3 meses desde fecha factura: 10%
- b) De 3 hasta 6 meses: 25%

En ningún caso se aceptarán devoluciones de material no defectuoso pasados los 6 meses posteriores a la fecha factura de venta.

No se aceptarán devoluciones de producto que hayan sido probados, usados o manipulados ni tampoco los que no lleven su embalaje original en perfecto estado bajo ningún concepto.

En ningún caso se aceptarán devoluciones de material personalizado para el cliente.

Reclamaciones y garantía

Cualquier defecto u anomalía, incluida la falta de calidad asegurada en el producto, debe ser comunicada por escrito en el momento de su detección. No serán aceptadas las reclamaciones por defectos una vez transcurridos 15 días hábiles de la recepción de la misma.

La garantía se extiende a todo defecto de producto de Ducha-Flex SCP, bien en sus materias primas base, como de construcción o fabricación, limitando nuestra responsabilidad a la sustitución de las piezas reconocidas por nosotros, sin dar lugar a indemnización alguna.

El proveedor podrá negarse a reparar los defectos si el cliente no cumple con sus obligaciones legales. El derecho del cliente para realizar una reclamación legal por defectos en la mercancía prescribe transcurrido un mes desde el rechazo, por parte del proveedor de la reclamación escrita.

Nos reservamos el derecho de modificar el diseño de nuestros productos sin previo aviso.

El servicio de la mano de obra y los desplazamientos siempre son a cargo del cliente.

Daños a destinatarios

En el supuesto caso de que el cliente tenga información de la producción de daños a un destinatario que pudieran ser derivados de los productos deberá notificarlo rápidamente a Duchaflex por escrito y facilitar la comprobación y peritaje de dichos daños y sus posibles causas a fin de poder establecer de quién pudiesen venir las responsabilidades y no dejar a Duchaflex en un estado de absoluta indefensión.

En cualquier caso se establece como límite máximo de la responsabilidad civil que asumirá Duchaflex de daños causados por los productos en el caso de que se demostrase que es su responsabilidad en un importe de 1.500.- €

Jurisdicción

Respecto a todos los litigios que surgieran en el marco de la relación contractual entre el proveedor y el cliente serán competentes los Juzgados y Tribunales de Barcelona.

De la misma manera se acuerda como Derecho aplicable el Derecho Español.



Polígono Industrial La Masía
C/ Mitjer, nave 9
08798 Sant Cugat Sesgarrigues
Barcelona

Tel.: +34 93 897 01 60
Fax: +34 93 897 02 32
mail: info@duchaflex.com
web: www.duchaflex.com